



Contactors Bulletin 100-M, 100-C, CAB6

- **Bulletin 100-M**
2.2 ... 5.5 kW
- **Bulletin 100-C**
4 ... 45 kW
- **Bulletin CAB6**
45 ... 220 kW

Pages
 4-9 ... 4-64

Bulletin 100S, 104S Safety Contactors

- **Bulletin 100S, 104S**
4 ... 45 kW



Bulletin 100-G Contactors

- **Bulletin 100-G**
315 ... 710 kW

Pages
 4-65 ... 4-78

Contactor Overview

AC-3 / 400 VAC

						100-G (550...1200 A)
					CAB6 (85...420 A)	
			100-C (9...85 A)			
	100-M (5...12 A)					
[kW]	2.2	4	5.5	45	220	710

Contactors

Overview - Bulletin 100-M

4

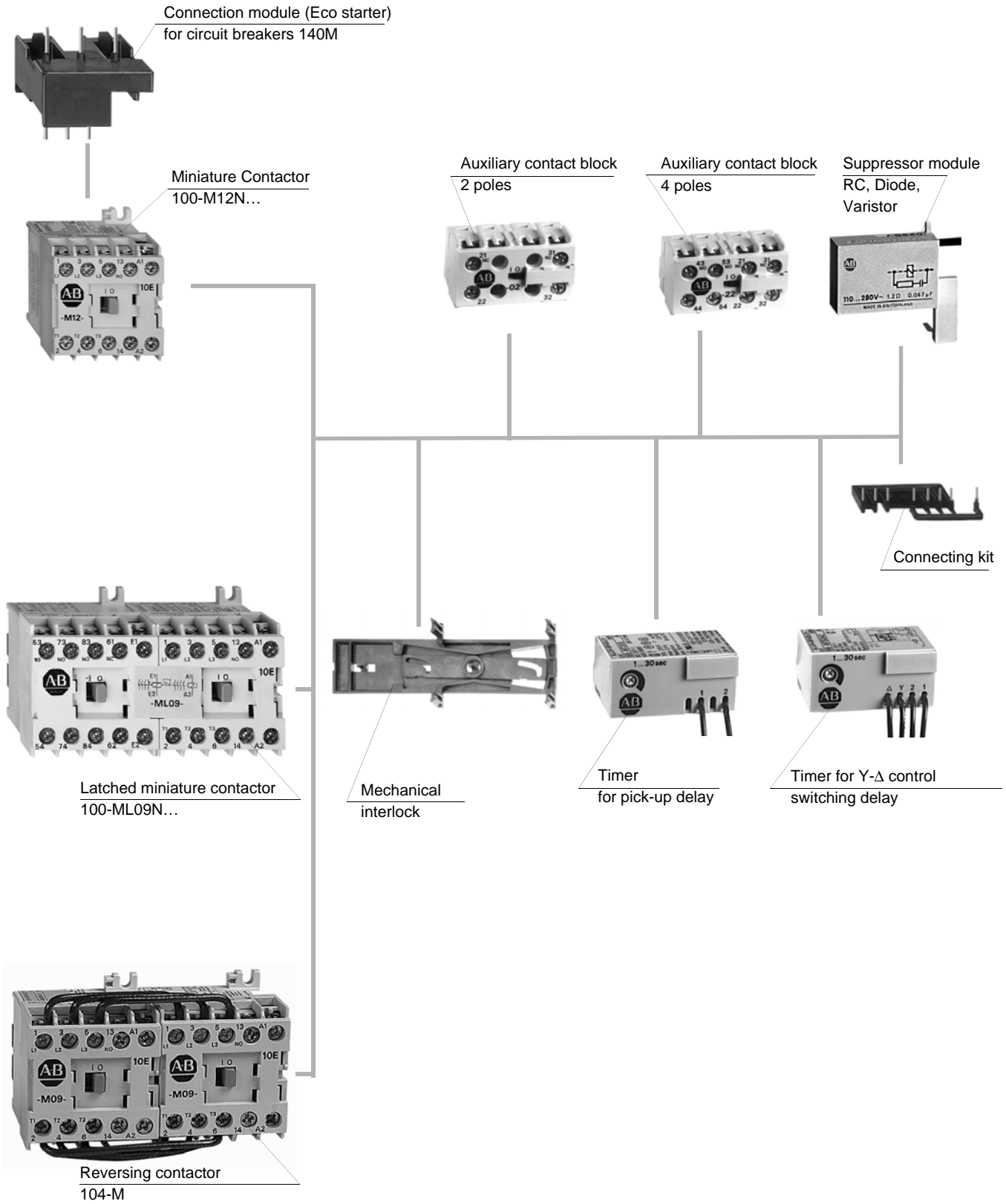

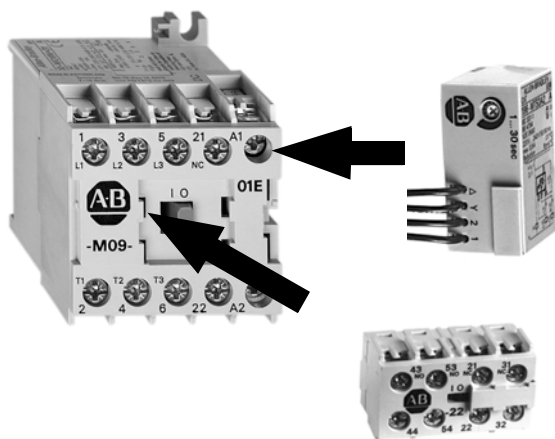

Minimum Space Requirements for Accessories

Auxiliary contact blocks and timers can be mounted onto the contactor without requiring additional panel space.

4

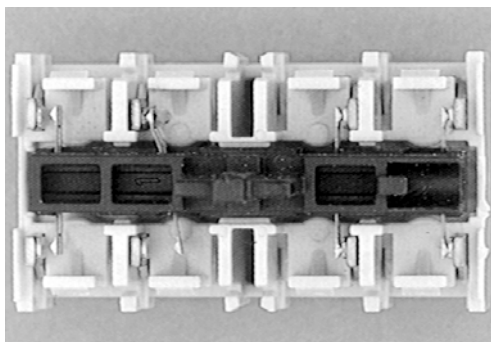

Positive Guidance of the Contacts

Positive guidance of the contacts according to IEC 60947-5-1 is given when it is ensured, that N.C. and N.O. contacts can never be closed at the same time. Therefore a minimum opening distance of 0.5 mm is prescribed in the event of failure. All contacts in the basic device are positively guided as well as the normally closed contacts in the auxiliary contact block except Bulletin 700-MB bifurcated contacts. This permits use within safety controls.

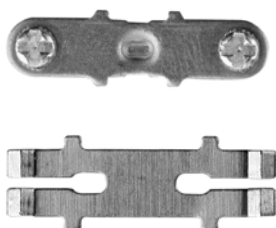

High Contact Reliability

Bulletin 100-M Miniature Contactors are rated for extra-low voltage. In addition to the isolation of the contact housing, high contact reliability is ensured by the special design of the auxiliary contacts:

- cross-stamped in the main contactor
- in the auxiliary contact block and in the bifurcated contacts (see chapter 8, Bulletin 700-M timers), H-contact bridges with constant sliding rolling motion and 4 multiple current path.

Contactors

Overview - Bulletin 100-C

4

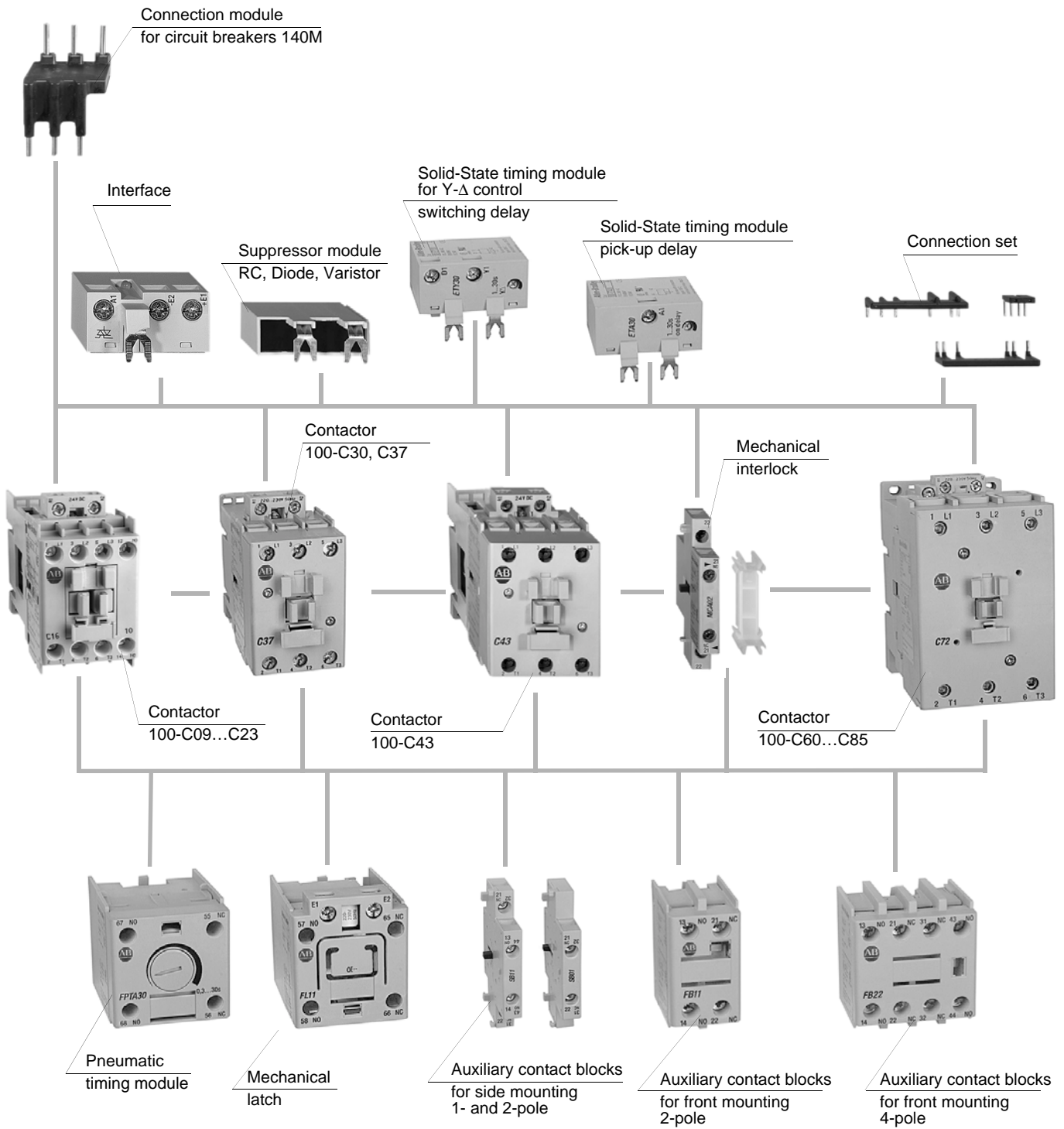

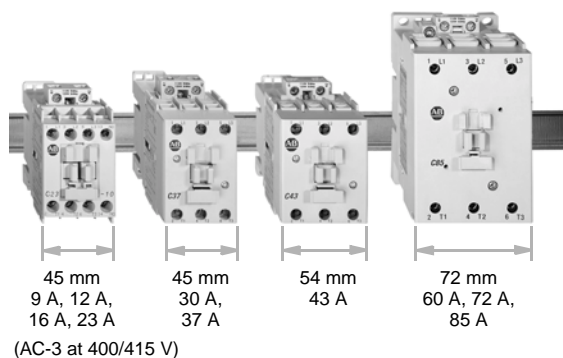

Compact design

Bulletin 100-C contactors switch more power and use less panel space. Despite their small dimensions, they are powerful enough for use with the high starting currents of today's modern motors.

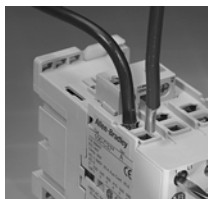

Bulletin 100-C contactors for good connections

Two separate power connections per pole offer ease of wiring and high connection reliability. The modern connection technology used by Bulletin 100-C contactors saves both time and money.

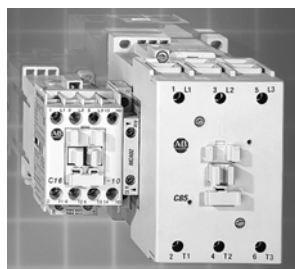

Coil always positioned correctly

The dual connection technology always positions the coil connection for optimal accessibility, whether below (on starters with circuit breakers), or above (on starters using the revolutionary Bulletin 193-E Electronic Overload relay). Space- and cost-saving coil modules (interface devices, protection elements, Electronic timers) can always be added. When ordering, select the desired position of the coil connections. The position of the coil connections can also be adapted locally within seconds, using simple tools.

Uniform accessories for the entire line of contactors

All Bulletin 100-C accessories can be used with all contactor sizes. The mechanical interlock with integrated interlock contacts can be used alone to interlock the smallest AC contactor with the largest.



Bulletin 100-C contactors for highest security

Bulletin 100-C contactors are rated for high personal protection and functional security. The safety package consists of amongst other things finger and back of hand accidental contact protection.

- Secure isolation of electric circuits
- Positively guided contacts
- Cover to prevent manual operation.

Comprehensive Safety for Operating Personnel and the Machine

The safety of both operators and machinery becomes more and more important. Electrical controls can play an important contribution to safety. Various rules and standards define the components and systems that are used in safety applications.

- Positively guided contacts according to IEC 947-5-1
- Fixed coupling of contactor and auxiliary contact block
- Protection against unintended actuation
- Auxiliary contacts that are electronically compatible according to DIN 19240



Positive Guidance of the Contacts

Positive guidance of contacts according to IEC 60947-5-1 is given when it is ensured, that N.C. and N.O. contacts are never able to be closed at the same time. Therefore a minimum opening distance of 0.5 mm is prescribed in the event of failure. All contacts in the basic device are positively guided as well as the normally closed contacts in the auxiliary contact block. The contacts in the basic device as well as in the auxiliary contact blocks are guided restricted. The restricted guidance also applies between basic device and accessories.

Contactors

Overview - Bulletin CAB6

4

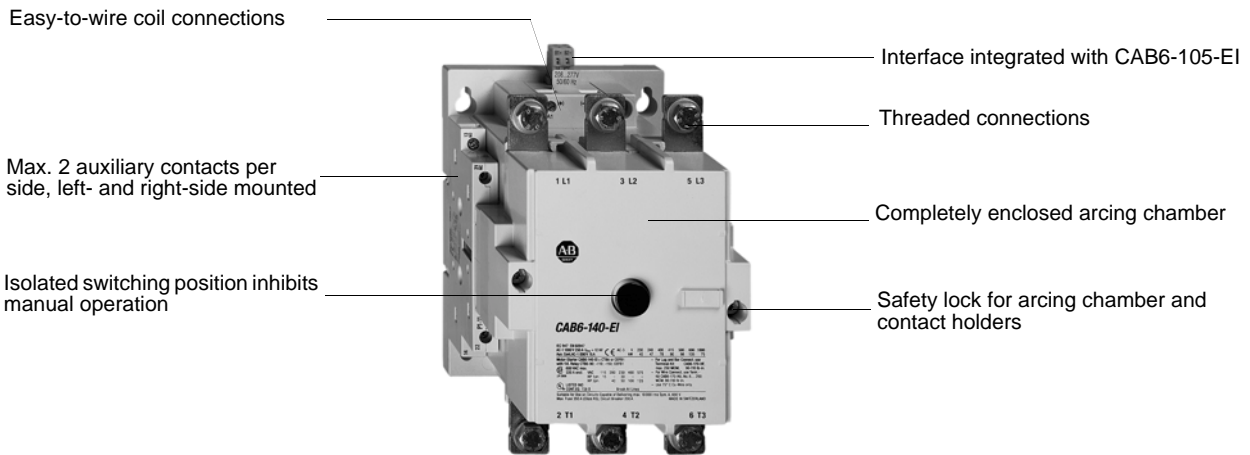
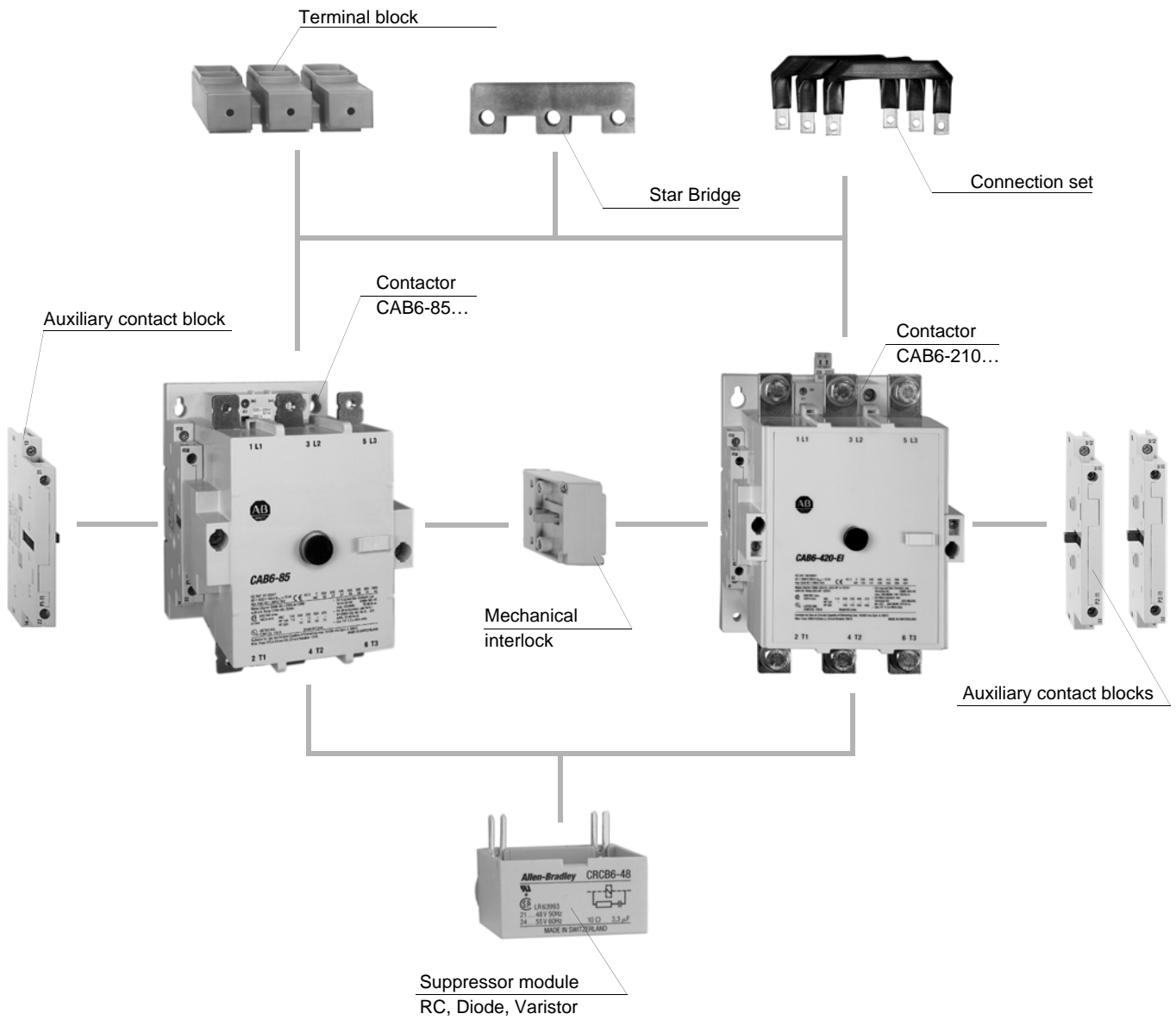

Bulletin CAB6 Contactors with electronically controlled Coil Mechanism

Bulletin CAB6 contactors are equipped with electronically controlled coil mechanisms and integrated interface starting from size CAB6-105-EI. Size CAB6-85 is equipped with conventional coils and sizes CAB6-105 and CAB6-140 can be equipped with either conventional or electronic coils. Contactors with electronic coils are characterised by the -EI suffix. By offering control options, a multitude of possibilities are at the user's disposal:

- **Integrated interface**

The factory supplied CAB6-EI range features an interface module that can be activated and deactivated via an externally accessible jumper unit. With the interface, the contactor can be addressed directly by a 24 V DC signal from a programmable logic controller. The max. allowable current of the interface is 15 mA (DIN VDE 19240). The Interface input is separated from the coil circuit by photoelectric.

- **Protective circuit included**

All EI-type contactors have a protective circuit as standard.

- **Low pick-up and holding power**

When compared with conventional contactors, the current requirement is substantially lowered by the construction of the contactor, particularly via the electronic control.

- **Wide voltage range**

Despite the wide voltage range (e.g., 208...277 V AC) the min./max. values of the IEC tolerances are kept between -0.85 and +1.1.

- **Compact dimensions**

New, compact construction solutions and the application of electronics substantially reduces the dimensions. Two housing sizes cover the entire range from 85...420 A (AC-3). Simple and efficient wiring is ensured by the identical connection height of the main pole on both housing sizes.

Bulletin CAB6 contactors can be mechanically interlocked, without needing additional mounting space.



CAB6-85...170

CAB6-210...420

- **Defined on- and off- points**

Electronic control guarantees defined points of switching on and off, thus preventing chatter and damage to the contactor.

- **Environmentally friendly**

Construction and contact materials do not contain cadmium, asbestos or PCBs and can be recycled at the end of the contactor life. Most plastic parts are characterised according to DIN 54840.

- **Frame terminal blocks**

Go safe! Contact protection is fulfilled by attachable terminal covers according to DIN VDE 0106 and VBG 4. By using framework terminal blocks the contactor automatically becomes finger-safe per IP20.



Contactors

4

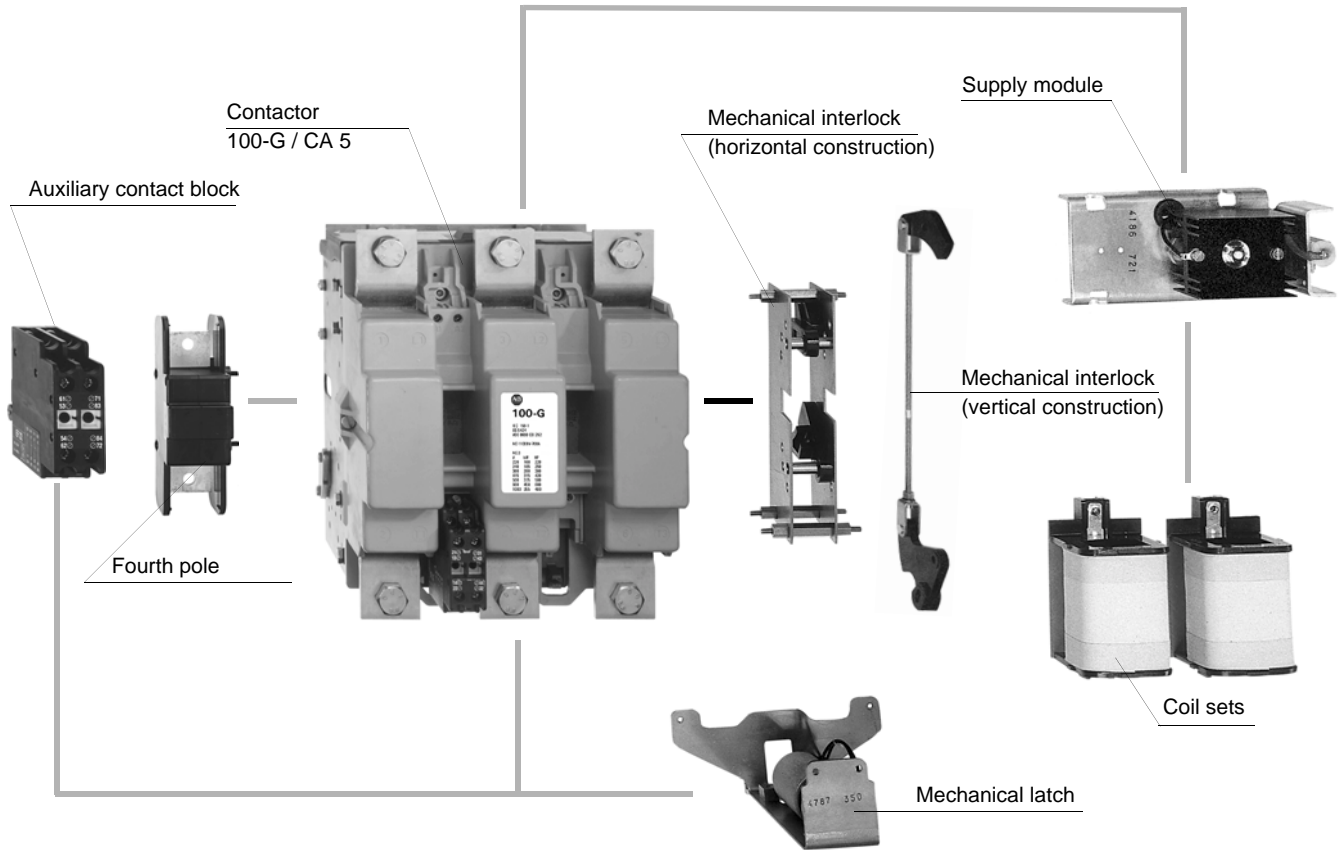

Good reasons to select Rockwell Automation contactors

- Allen-Bradley contactors are built for a global marketplace and fulfill all applicable IEC 947 requirements.
- Worldwide acceptance and high stock availability in all countries increases security for the user.
- A wide range of accessories (e.g., auxiliary contact blocks, interfaces, control and timing modules) make contactors ideal and economical building blocks for individual control needs.

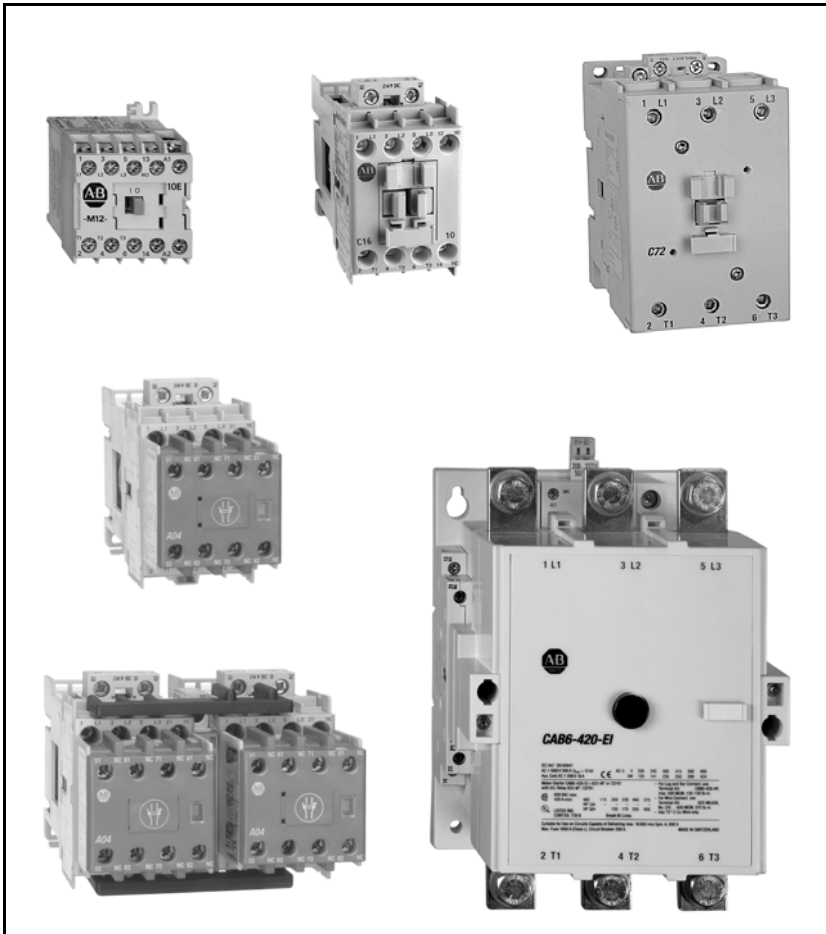

Bulletin 100-M Miniature Contactors

- **Bulletin 100-M**
 2.2 ... 5.5 kW (5 ... 12 A)

Bulletin 100-C, CAB6 Contactors

- **Bulletin 100-C**
 4 ... 45 kW (9 ... 85 A)
- **Bulletin 104-C**
 4 ... 45 kW (9 ... 85 A)
- **Bulletin CAB6**
 45 ... 220 kW (85 ... 420 A)

Bulletin 100S, 104S Safety Contactors

- **Bulletin 100S-C**
 4 ... 45 kW (9 ... 85 A)
- **Bulletin 104S-C**
 4 ... 45 kW (9 ... 85 A)

Table of Contents

Description	Page	Description	Page
Overview	4-2	Specifications	
Product Selection		Performance Data / Characteristics	4-36
AC Control	4-10	Weight	4-44
DC Control	4-12	Standards and Approvals	4-49
Special Versions	4-14	Electrical Data	4-51
Reversing Contactors	4-16	Permissible Switching Rate	4-57
Safety Contactors	4-18	Dimensions	4-61
Accessories			
Modules	4-24		
Mounting Materials	4-31		
Labelling Material	4-33		
Renewal Parts	4-33		

Contactors

Product Selection



3-pole Contactors

- AC control
- 3 main contacts



4

AC-1 (40 °C)	Switching of 3-phase Motors AC-2, AC-3, AC-4 (60 °C)								Auxiliary Contacts Integrated		Cat. No.	PQ	
	[kW] ❶				[A]								
	[A]	230 V	400 / 415 V	500 V	690 V	230 V	400 / 415 V	500 V					690 V
20	1.5	2.2	2.2	—	6.5	5.3	4	—	1	0	100-M05N	⊗ 3	⊕
									0	1	100-M05N	⊗ 31	⊕
20	3	4	4	—	12	9	7	—	1	0	100-M09N	⊗ 3	⊕
									0	1	100-M09N	⊗ 31	⊕
20	3	5.5 ❷	4	—	12	12 ❸	7	—	1	0	100-M12N	⊗ 3	⊕
									0	1	100-M12N	⊗ 31	⊕
32	3	4	4	4	12	9	7	5	1	0	100-C09	⊕ ⊗ 10	★
									0	1	100-C09	⊕ ⊗ 01	★
32	4	5.5	5.5	5.5	15	12	10	7	1	0	100-C12	⊕ ⊗ 10	★
									0	1	100-C12	⊕ ⊗ 01	★
32	5.5	7.5	7.5	7.5	20	16	14	9	1	0	100-C16	⊕ ⊗ 10	★
									0	1	100-C16	⊕ ⊗ 01	★
32	7.5	11	13	10	26.5	23	20	12	1	0	100-C23	⊕ ⊗ 10	★
									0	1	100-C23	⊕ ⊗ 01	★
50	10	15	15	15	35	30	25	18	0	0	100-C30	⊕ ⊗ 00	★
50	11	18.5 / 20	20	18.5	38	37	30	21	0	0	100-C37	⊕ ⊗ 00	★
85	13	22	25	22	44	43	38	25	0	0	100-C43	⊕ ⊗ 00	
100	18.5	32	37	32	62	60	55	34	0	0	100-C60	⊕ ⊗ 00	
100	22	40	45	40	72	72	67	42	0	0	100-C72	⊕ ⊗ 00	
100	25	45	55	45	85	85	80	49	0	0	100-C85	⊕ ⊗ 00	
160	25	45	55	80	85	85	85	85	0	0	CAB6-85-00-	⊗	
									1	1	CAB6-85-11-	⊗	
160	32	55	63	100	105	105	105	105	0	0	CAB6-105-00-	⊗	
									1	1	CAB6-105-11-	⊗	
									0	0	CAB6-105-EI-00-	⊗	
									1	1	CAB6-105-EI-11-	⊗	
250	45	75	80	110	140	140	115	115	0	0	CAB6-140-00-	⊗	
			90	132	140	140	140	140	1	1	CAB6-140-11-	⊗	
			0	0	CAB6-140-EI-00-	⊗							
			1	1	CAB6-140-EI-11-	⊗							
250	55	90 / 100	110	160	170	170	170	170	0	0	CAB6-170-EI-00-	⊗	
									1	1	CAB6-170-EI-11-	⊗	
350	63	110	150	200	210	210	210	210	0	0	CAB6-210-EI-00-	⊗	
									1	1	CAB6-210-EI-11-	⊗	
350	80	132 / 150	160	250	250	250	250	250	0	0	CAB6-250-EI-00-	⊗	
									1	1	CAB6-250-EI-11-	⊗	
450	90	160	200	300	300	300	300	300	0	0	CAB6-300-EI-00-	⊗	
									1	1	CAB6-300-EI-11-	⊗	
500	132	220 / 250	300 ❸	425 ❸	420	420	420 ❸	420 ❸	0	0	CAB6-420-EI-00-	⊗	
									1	1	CAB6-420-EI-11-	⊗	

Bulletin CAB contactors are suitable for use with operating voltages up to 1000V. Bulletin CAB6-...-EI contactors are equipped with electronic coil control ⊕ ⊗

❶ Power ratings: Preferred values according to IEC 60072-1

❷ Value applies only to AC-2 and AC-3

❸ Value applies only to AC-2 and AC-3; AC-4: 360 A

PQ = Package Quantity

Accessories - Page 4-24

Specifications - Page 4-36

Dimensions - Page 4-61

Selection of Options

Options	Cat. No. Suffix	Description	Ordering Example
⊕ Coil connection position	No Entry	⊆ Line-side coil connection (above, standard quantity)	100-C09⊗10
	U	⊆ Load-side coil connection (below)	100-C09 U ⊗10
⊗ Voltage suffix code	e.g. KJ	Voltage suffix code from table below	100-C09 KJ 10
⊕ Package quantity 100-M	No Entry	⊆ Multi-pack (10 pieces) (Only KD, D, KF, KK)	100-M09N⊗3
	S	⊆ Single item (1 piece, standard quantity)	100-M09N⊗3 S
★ Package quantity 100-C	No Entry	⊆ Single item (1 piece, standard quantity)	100-C09⊗10
	M	⊆ Multi-pack (20 pieces)	100-C09⊗10 M

Attention:

 Bulletin 100-M...**S**: standard quantity = single item (1 piece)

Bulletin 100-C, CAB6: standard quantity = single item (1 piece)

⊗ Voltage Suffix Codes for AC Control

100-M	[V]	24	48	110	110-120	230	220-230	230-240	240	380-400	400-415						
	50 Hz	—	—	D	—	—	(A)	—	—	KK	—						
	60 Hz	—	—	—	D	—	—	(A)	—	—	KK						
	50/60 Hz	KD	KH	—	—	KF	—	—	(KT)	—	—						
100-C	[V]	12	24	32	36	42	48	100	100-110	110	120	127	200	200-220	200-230	208-240	
	50 Hz	(R)	(K)	(V)	(W)	(X)	(Y)	(KP)	—	(D)	(P)	(S)	(KG)	—	—	—	
	60 Hz	(Q)	(J)	—	(V)	—	(X)	—	(KP)	—	(D)	—	—	(KG)	—	(L)	
	50/60 Hz	—	KJ	—	—	—	KY	(KP)	—	KD	—	—	(KG)	—	(KL)	—	
	[V]	220-230	230	230-240	240	277	347	380	380-400	400	400-415	440	480	500	550	600	
	50 Hz	(F)	—	(VA)	(T)	—	—	—	(N)	—	(G)	(B)	—	(M)	(C)	—	
60 Hz	—	—	—	(A)	(T)	(I)	(E)	—	—	—	(N)	(B)	—	—	(C)		
50/60 Hz	—	KF	—	(KA)	—	—	—	—	KN	—	(KB)	—	—	—	—		
CAB6-85...CAB6-140 ④	[V]	24	28	48	55	110	127	220-230	230	240	260	277	380-400	415	440-460	480	
	50 Hz	05	—	08	—	10	—	13	—	(15)	—	—	16	(17)	—	—	
	60 Hz	—	05	—	08	—	10	—	—	—	13	(15)	—	—	16	(17)	
	50/60 Hz	—	—	—	—	(48)	—	—	54	(55)	—	—	—	—	—	—	
CAB6-105-EI...CAB6-250-E ⑤	[V]	24-28	43-65	110-130	208-277	380-400											
	50/60 Hz	05	08	10	14	16											
CAB6-300-EI...CAB6-420-EI ⑥	50/60 Hz	—	08	10	14	16											

Price Adder for:	Type	Available Control Voltages	No Surcharge
Special control voltages	100-M	12...500 V 50 Hz, 12...600 V 60 Hz	> 25 pieces
	100-C	12...600 V 50 Hz, 12...600 V 60 Hz	> 20 pieces
	CAB6-85...CAB6-140 ④	21...550 V 50 Hz, 21...575 V 60 Hz, 110...240 V 50/60 Hz	> 25 pieces

() Control voltages in parentheses: No inventory

④ 50/60 Hz coil only available for CAB6-85 and 105

⑤ Signal voltage of the CAB6...EI electronic interface:

 U_e : 24 VDC / I_e : 15 mA
 Logical 1: 13.0 VDC...30.2 VDC
 Logical 0: -3.0 VDC...+5.0 VDC

Contactors

Product Selection

3-pole Contactors

- DC control
- 3 main contacts



100-M.Z



100-C.Z



100-C.Z



CAB6

4

AC-1 (40 °C)	Switching of 3-phase Motors AC-2, AC-3, AC-4 (60 °C)								Auxiliary Contacts Internal		Cat. No.	PQ			
	[kW] ❶				[A]				1 	0 					
[A]	230 V	400 / 415 V	500 V	690 V	230 V	400 / 415 V	500 V	690 V							
20	1.5	2.2	2.2	—	6.5	5.3	4	—	1	0	100-M05N	⊗ 3	⊕		
									0	1				100-M05N	⊗ 31
20	3	4	4	—	12	9	7	—	1	0	100-M09N	⊗ 3	⊕		
									0	1				100-M09N	⊗ 31
20	3	5.5 ❷	4	—	12	12 ❷	7	—	1	0	100-M12N	⊗ 3	⊕		
									0	1				100-M12N	⊗ 31
32	3	4	4	4	12	9	7	5	1	0	100-C09	⊕ ⊗ 10	★		
									0	1				100-C09	⊕ ⊗ 01
32	4	5.5	5.5	5.5	15	12	10	7	1	0	100-C12	⊕ ⊗ 10	★		
									0	1				100-C12	⊕ ⊗ 01
32	5.5	7.5	7.5	7.5	20	16	14	9	1	0	100-C16	⊕ ⊗ 10	★		
									0	1				100-C16	⊕ ⊗ 01
32	7.5	11	13	10	26.5	23	20	12	1	0	100-C23	⊕ ⊗ 10	★		
									0	1				100-C23	⊕ ⊗ 01
50	10	15	15	15	35	30	25	18	0	0	100-C30	⊕ ⊗ 00	★		
50	11	18.5 / 20	20	18.5	38	37	30	21	0	0	100-C37	⊕ ⊗ 00	★		
85	13	22	25	22	44	43	38	25	0	0	100-C43	⊕ ⊗ 00	1		
100	18.5	32	37	32	62	60	55	34	0	0	100-C60	⊕ ⊗ 00			
100	22	40	45	40	72	72	67	42	0	0	100-C72	⊕ ⊗ 00			
100	25	45	55	45	85	85	80	49	0	0	100-C85	⊕ ⊗ 00			
160	25	45	55	80	85	85	85	85	2	2	CAB6-85-L22-	⊗			
									2	2				CAB6-105-L22-	⊗
									0	0				CAB6-105-EI-00-	⊗
160	32	55	63	100	105	105	105	105	1	1	CAB6-105-EI-11-	⊗			
									2	2				CAB6-140-L22-	⊗
									0	0				CAB6-140-EI-00-	⊗
250	45	75	80	110	140	140	115	115	2	2	CAB6-140-EI-11-	⊗			
			90	132	140	140	140	140	0	0				CAB6-170-EI-00-	⊗
250	55	90 / 100	110	160	170	170	170	170	1	1	CAB6-170-EI-11-	⊗	1		
			160	200	210	210	210	210	0	0				CAB6-210-EI-00-	⊗
350	63	110	150	200	210	210	210	210	1	1	CAB6-210-EI-11-	⊗			
			200	250	250	250	250	250	0	0				CAB6-250-EI-00-	⊗
350	80	132 / 150	160	250	250	250	250	250	1	1	CAB6-250-EI-11-	⊗			
			200	300	300	300	300	300	0	0				CAB6-300-EI-00-	⊗
450	90	160	200	300	300	300	300	300	1	1	CAB6-300-EI-11-	⊗			
			300	420	420	420	420	420	0	0				CAB6-420-EI-00-	⊗
500	132	220 / 250	300 ❸	425 ❸	420	420	420 ❸	420 ❸	1	1	CAB6-420-EI-11-	⊗			
			425	500	500	500	500	500							

Bulletin CAB contactors are suitable for use with operating voltages up to 1000V. Bulletin CAB6-...-EI contactors are equipped with electronic coil control

- ❶ Power ratings: Preferred values according to IEC 60072-1
- ❷ Value applies only to AC-2 and AC-3
- ❸ Value applies only to AC-2 and AC-3; AC-4: 360 A

PQ = Package Quantity

Accessories - Site 4-24
 Specifications - Page 4-36
 Dimensions - Page 4-61

Selection of Options

Options	Cat. No. Suffix	Description	Ordering Example
⊕ Coil connection position	No Entry	⊆ Line-side coil connection (above, standard quantity)	100-C09⊗10
	U	⊆ Load-side coil connection (below)	100-C09 U ⊗10
⊗ Voltage suffix code	e.g. ZJ	Voltage suffix code from table below	100-C09 ZJ 10
⊛ Package quantity 100-M	No Entry	⊆ Multi-pack (10 pieces) (Only Z24, ZD24)	100-M09N⊗3
	S	⊆ Single item (1 piece, standard quantity)	100-M09N⊗3 S
★ Package quantity 100-C	No Entry	⊆ Single item (1 piece, standard quantity)	100-C09⊗10
	M	⊆ Multi-pack (20 pieces)	100-C09⊗10 M

Attention:

 Bulletin 100-M...**S**: standard quantity = single item (1 piece)

Bulletin 100-C, CAB6: standard quantity = single item (1 piece)

⊗ Voltage Suffix Codes for DC Control

100-M	[V]	24	48	110	220											
	DC	Z24	(Z48)	Z11	(Z2)											
	with diode protection circuit	DC	ZD24	—	—											
100-C09...C43	[V]	9 ⊕	12	24 ⊕	36	48	60	64	72	80	110	115	125	220	230	250
	DC	(ZR)	(ZQ)	ZJ	(ZW)	(ZY)	(ZZ)	(ZB)	(ZG)	(ZE)	ZD	(ZP)	(ZS)	(ZA)	(ZF)	(ZT)
	with diode protection circuit	DC	—	—	DJ	—	—	—	—	—	—	—	—	—	—	—
100-C60...C85	[V]	24	48	110	220											
	DC	—	—	—	—	—	—	—	—	—	—	—	—	—	—	—
	with diode protection circuit	DC	(DR)	(DQ)	DJ	(DW)	(DY)	(DZ)	(DB)	(DG)	(DE)	DD	(DP)	(DS)	(DA)	(DF)
CAB6-85...CAB6-140 ⊕	[V]	24	48	110	220											
	DC	66	(70)	76	(86)											
CAB6-105-EI...CAB6-300-EI	[V]	24- 28	48- 72	90- 135	110- 135	170- 255	190- 255									
	DC	66	(70)	76	—	(86)	—									
CAB6-420-EI	DC	—	(70)	—	76	—	(86)									

Price Adder for:	Type	Available Control Voltages	No Surcharge
Special control voltages	100-M..Z	12...250 VDC	> 25 pieces
	100-C..Z	12...250 VDC	> 20 pieces
	CAB6-85...CAB6-140	24...240 VDC	> 25 pieces

 () **Control voltages in parentheses:** No inventory

 ⊕ Extended operating limits $0.65...1.3 \times U_s$

 ⊕ Extended operating limits $0.7...1.25 \times U_s$

⊕ With conventional DC control, the pickup winding must be interconnected with the late-breaking auxiliary contacts

Contactors

Product Selection



Special Versions

- AC / DC control
- 4-pole contactors
- Latched contactors



100-M



100-C

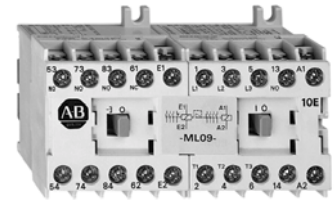

100-ML

4-pole Contactors Bulletin 100-M, 100-C

AC-1 (40°C)	Switching of 3-phase Motors AC-2, AC-3, AC-4 Ⓛ (60 °C)								Main Poles (Fitted)		Available Options	Cat. No.	PQ	
	[kW] Ⓛ				[A]									
	230 V	400 / 415 V	500 V	690 V	230 V	400 / 415 V	500 V	690 V						
[A]	230 V	400 / 415 V	500 V	690 V	230 V	400 / 415 V	500 V	690 V						
20	3	4	4	—	12	9	7	—	4	0	AC/DC	100-M09N	⊗ 4	Ⓛ
32	7.5	11	13	10	26.5	23	20	12	4	0	AC/DC	100-C23	⊕ ⊗ 400	★
									3	1	AC/DC Ⓛ	100-C23	⊕ ⊗ 300	★
									2	2		100-C23	⊕ ⊗ 200	★

(4-pole 100-C09...C16 contactors available upon request)

Latched Contactors Bulletin 100-ML

AC-1 (40°C)	Switching of 3-phase Motors AC-2, AC-3, AC-4 (60 °C)								Auxiliary Contacts Latched Contactors		Available Options	Cat. No.	PQ
	[kW]				[A]								
	230 V	400 / 415 V	500 V	690 V	230 V	400 / 415 V	500 V	690 V					
[A]	230 V	400 / 415 V	500 V	690 V	230 V	400 / 415 V	500 V	690 V					
20	3	4	4	—	12	9	7	—	1	0	AC	100-ML09NⓁ3	1
									0	1	AC	100-ML09NⓁ31	

Options	Cat. No. Suffix	Description	Ordering Example
Ⓛ Coil connection position	No Entry	≙ Line-side coil connection (above, standard quantity)	100-C23Ⓛ400
	U	≙ Load-side coil connection (below)	100-C23UⓁ400
⊗ Tension de commande	e.g. KJ	Voltage suffix code from table below	100-C23KJ400
Ⓛ Package quantity 100-M	No Entry	≙ Multi-pack (10 pieces) (Only KD, D, KF, KK, Z24, ZD24)	100-M09NⓁ4
	S	≙ Single item (1 piece, standard quantity)	100-M09NⓁ4S
★ Package quantity 100-C	No Entry	≙ Single item (1 piece, standard quantity)	100-C23Ⓛ400
	M	≙ Multi-pack (20 pieces)	100-C23Ⓛ400M

Ⓛ AC-4 value only for contact assembly with 3 resp, 4 N.O. contacts

Ⓛ Power ratings: Preferred values according to IEC 60072-1

Ⓛ No inventory



Attention:

Bulletin 100-M...S: standard quantity = single item (1 piece)

Bulletin 100-C: standard quantity = single item (1 piece)

PQ = Package Quantity

Accessories - Site 4-24
Specifications - Page 4-36
Dimensions - Page 4-61

⊗ Voltage Suffix Codes for AC Control

100-M	[V]	24	48	110	110-120	230	220-230	230-240	240	380-400	400-415						
	50 Hz	—	—	D	—	—	(A)	—	—	KK	—						
	60 Hz	—	—	—	D	—	—	(A)	—	—	KK						
	50/60 Hz	KD	KH	—	—	KF	—	—	(KT)	—	—						
100-C	[V]	12	24	32	36	42	48	100	100-110	110	120	127	200	200-220	200-230	208-240	
	50 Hz	(R)	(K)	(V)	(W)	(X)	(Y)	(KP)	—	(D)	(P)	(S)	(KG)	—	—	—	
	60 Hz	(Q)	(J)	—	(V)	—	(X)	—	(KP)	—	(D)	—	—	(KG)	—	(L)	
	50/60 Hz	—	KJ	—	—	—	KY	(KP)	—	KD	—	—	(KG)	—	(KL)	—	
	[V]	220-230	230	230-240	240	277	347	380	380-400	400	400-415	440	480	500	550	600	
	50 Hz	(F)	—	(VA)	(T)	—	—	—	(N)	—	(G)	(B)	—	(M)	(C)	—	
	60 Hz	—	—	—	(A)	(T)	(I)	(E)	—	—	(N)	(B)	—	—	—	(C)	
50/60 Hz	—	KF	—	(KA)	—	—	—	—	KN	—	(KB)	—	—	—	—		

⊗ Voltage Suffix Codes for DC Control

100-M	[V]	24	48	110	220												
	DC	Z24	(Z48)	Z11	(Z2)												
	with diode protection circuit	DC	ZD24	—	—												
100-C09...C43	[V]	9 ④	12	24 ⑥	36	48	60	64	72	80	110	115	125	220	230	250	
	DC	(ZR)	(ZQ)	ZJ	(ZW)	(ZY)	(ZZ)	(ZB)	(ZG)	(ZE)	ZD	(ZP)	(ZS)	(ZA)	(ZF)	(ZT)	
	with diode protection circuit	DC	—	—	DJ	—	—	—	—	—	—	—	—	—	—	—	
100-C60...C85	DC	—	—	—	—	—	—	—	—	—	—	—	—	—	—	—	
	with diode protection circuit	DC	(DR)	(DQ)	DJ	(DW)	(DY)	(DZ)	(DB)	(DG)	(DE)	DD	(DP)	(DS)	(DA)	(DF)	(DT)

Price Adder for:	Type	Available Control Voltages	No Surcharge
Special control voltages	100-M	12...500 V 50 Hz, 12...600 V 60 Hz, 12...250 VDC	> 25 pieces
	100-C	12...600 V 50 Hz, 12...600 V 60 Hz, 12...250 VDC	> 20 pieces

() Control voltages in parentheses: No inventory

 ④ Extended operating limits $0.65...1.3 \times U_s$

 ⑥ Extended operating limits $0.7...1.25 \times U_s$

Contactors

Product Selection

Reversing Contactors

- 3 main contacts, coil connections above
- Mechanical / Electrical interlock included
- Wiring set for main pole interconnection included

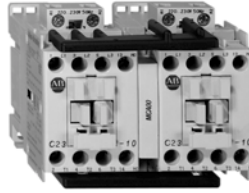

4

AC-1 (40°C)	Switching of 3-phase Motors AC-2, AC-3, AC-4 (60 °C)								Auxiliary Contact per Contactor		Auxiliary Contact on Interlock	Cat. No.	PQ	
	[kW] ①				[A]				⎓	⎓	⎓			
	230 V	400 / 415 V	500 V	690 V	230 V	400 / 415 V	500 V	690 V						
20	1.5	2.2	2.2	—	6.5	5.3	4	—	1	0	0	② ③	104-M05N ⊗ 3	◆
									0	1	0			
20	3	4	4	—	12	9	7	—	1	0	0	② ③	104-M09N ⊗ 3	◆
									0	1	0			
20	3	5.5 ④	4	—	12	12 ④	7	—	1	0	0	② ③	104-M12N ⊗ 3	◆
									0	1	0			
32	3	4	4	4	12	9	7	5	1	0	0		104-C09 ⊗ 10 -E	◆
									0	1	0		104-C09 ⊗ 00 -E	◆
32	4	5.5	5.5	5.5	15	12	10	7	1	0	2		104-C12 ⊗ 10 -E	◆
									0	1	0		104-C12 ⊗ 00 -E	◆
32	5.5	7.5	7.5	7.5	20	16	14	9	1	0	2		104-C16 ⊗ 10 -E	◆
									0	1	0		104-C16 ⊗ 00 -E	◆
32	7.5	11	13	10	26.5	23	20	12	1	0	2		104-C23 ⊗ 10 -E	◆
									0	1	0		104-C23 ⊗ 00 -E	◆
50	10	15	15	15	35	30	25	18	0	0	2		104-C30 ⊗ 00 -E	◆
									0	0	2		104-C30 ⊗ 00 -E	◆
50	11	18.5 / 20	20	18.5	38	37	30	21	0	0	2		104-C37 ⊗ 00 -E	◆
									0	0	2		104-C37 ⊗ 00 -E	◆
85	13	22	25	22	44	43	38	25	0	0	2		104-C43 ⊗ 00 -E	◆
									0	0	2		104-C43 ⊗ 00 -E	◆
100	18.5	32	37	32	62	60	55	34	1	1	0	⑤	104-C60 ⊗ 10 -E	◆
									1	1	0	⑤	104-C60 ⊗ 10 -E	◆
100	22	40	45	40	72	72	67	42	1	1	0	⑤	104-C72 ⊗ 10 -E	◆
									1	1	0	⑤	104-C72 ⊗ 10 -E	◆
100	25	45	55	45	85	85	80	49	1	1	0	⑤	104-C85 ⊗ 10 -E	◆
									1	1	0	⑤	104-C85 ⊗ 10 -E	◆

Bulletin CAB contactors are suitable for use with operating voltages up to 1000V. Bulletin CAB6-...-EI contactors are equipped with electronic coil control

160	25	45	55	80	85	85	85	85	1	1	0	CAU	⊗	B6-85-	10	⊗
160	32	55	63	100	105	105	105	105	1	1	0	CAU	⊗	B6-105-	10	⊗
												CAU	⊗	B6-105-EI-	10	⊗
250	45	75	80	110	140	140	115	115	1	1	0	CAU	⊗	B6-140-	10	⊗
			90	132	140	140	140	140	140	1	1	0	CAU	⊗	B6-140-EI-	10
250	55	90 / 100	110	160	170	170	170	170	1	1	0	CAU	⊗	B6-170-EI-	10	⊗
350	63	110 / 125	150	200	210	210	210	210	1	1	0	CAU	⊗	B6-210-EI-	10	⊗
350	80	132 / 150	160	250	250	250	250	250	1	1	0	CAU	⊗	B6-250-EI-	10	⊗
450	90	160	200	300	300	300	300	300	1	1	0	CAU	⊗	B6-300-EI-	10	⊗
500	132	220 / 250	300 ⑥	425 ⑥	420	420	420 ⑥	420 ⑥	1	1	0	CAU	⊗	B6-420-EI-	10	⊗

Options	Cat. No. Suffix	Description	Ordering Example
◆ Mechanical interlock	No Entry	⊆ with mechanical interlock (standard)	104-M05N⊗3
	-X	⊆ without mechanical interlock	104-M05N⊗3-X
⊗ Mechanical interlock	No Entry	⊆ without mechanical interlock (standard)	CAU-B6-105-EI-10⊗
	M	⊆ with mechanical interlock	CAUMB6-105-EI-10⊗
⊗ Voltage suffix code	e.g. KJ	Voltage suffix code from the table on the next page	104-M05NKJ3

- ① Power ratings: Preferred values according to IEC 60072-1
- ② DC-control only available without mechanical interlock
- ③ For electronic interlock additional N.C. contacts required

- ④ Value applies only to AC-2 and AC-3
- ⑤ Bulletin 100-MCA00 mechanical interlock. Electrical interlock via the front mounted auxiliary contact block (2 pole)
- ⑥ Value applies only to AC-2 and AC-3; AC-4: 360 A

PQ = Package Quantity

Accessories - Page 4-24
 Specifications - Page 4-36
 Dimensions - Page 4-61

⊗ Voltage Suffix Codes for AC Control

104-M	[V]	24	48	110	110-120	230	220-230	230-240	240	380-400	400-415							
	50 Hz	—	—	D	—	—	(A)	—	—	KK	—							
	60 Hz	—	—	—	D	—	—	(A)	—	—	KK							
	50/60 Hz	KD	KH	—	—	KF	—	—	(KT)	—	—							
104-C	[V]	12	24	32	36	42	48	100	100-110	110	120	127	200	200-220	200-230	208	208-240	
	50 Hz	(R)	(K)	(V)	(W)	(X)	(Y)	(KP)	—	(D)	(P)	(S)	(KG)	—	—	—	—	
	60 Hz	(Q)	(J)	—	(V)	—	(X)	—	(KP)	—	(D)	—	—	(KG)	—	(H)	(L)	
	50/60 Hz	—	KJ	—	—	—	KY	(KP)	—	KD	—	—	(KG)	—	(KL)	—	—	
	[V]	220-230	230	230-240	240	277	347	380	380-400	400	400-415	440	480	500	550	600		
	50 Hz	(F)	—	(VA)	(T)	—	—	—	(N)	—	(G)	(B)	—	(M)	(C)	—		
	60 Hz	—	—	—	(A)	(T)	(I)	(E)	—	—	—	(N)	(B)	—	—	(C)		
	50/60 Hz	—	KF	—	(KA)	—	—	—	—	KN	—	(KB)	—	—	—	—		
CAUB6-85...CAUB6-140 ⑦	[V]	24	28	48	55	110	127	220-230	230	240	260	277	380-400	415	440-460	480		
	50 Hz	05	—	08	—	10	—	13	—	(15)	—	—	16	(17)	—	—		
	60 Hz	—	05	—	08	—	10	—	—	—	13	(15)	—	—	16	(17)		
	50/60 Hz	—	—	—	—	(48)	—	—	54	(55)	—	—	—	—	—	—		
CAUB6-105-EI...CAUB6-250-EI	[V]	24-28	43-65	110-130	208-277	380-400												
	50/60 Hz	05	08	10	14	16												
CAUB6-300-EI...CAUB6-420-EI	50/60 Hz	—	08	10	14	16												

⊗ Voltage Suffix Codes for DC Control

104-M	[V]	24	48	110	220												
	DC	Z24	(Z48)	Z11	(Z2)												
	with diode protection circuit	ZD24	—	—	—												
104-C09...C43	[V]	9 ⑧	12	24 ⑧	36	48	60	64	72	80	110	115	125	220	230	250	
	DC	(ZR)	(ZQ)	ZJ	(ZW)	(ZY)	(ZZ)	(ZB)	(ZG)	(ZE)	ZD	(ZP)	(ZS)	(ZA)	(ZF)	(ZT)	
	with diode protection circuit	—	—	DJ	—	—	—	—	—	—	—	—	—	—	—	—	
104-C60...C85	DC	—	—	—	—	—	—	—	—	—	—	—	—	—	—	—	
	with diode protection circuit	(DR)	(DQ)	DJ	(DW)	(DY)	(DZ)	(DB)	(DG)	(DE)	DD	(DP)	(DS)	(DA)	(DF)	(DT)	
CAB6-85...CAB6-140	[V]	24	48	110	220												
	DC	66	(70)	76	(86)												
CAB6-105-EI...CAB6-300-EI	[V]	24-28	48-72	90-135	110-135	170-255	190-255										
	DC	66	(70)	76	—	(86)	—										
	CAB6-420-EI	DC	—	(70)	—	76	—	(86)									

Price Adder for:	Type	Available Control Voltages	No Surcharge
Special control voltages	104-M	12...500 V 50 Hz, 12...600 V 60 Hz, 12...250 VDC	> 25 pieces
	104-C	12...600 V 50 Hz, 12...600 V 60 Hz, 12...250 VDC	> 20 pieces
	CAUB6-85...CAUB6-140 ⑦	21...550 V 50 Hz, 21...575 V 60 Hz, 110...240 V 50/60 Hz, 24...240 VDC	> 25 pieces

() Control voltages in parentheses: No inventory

E Wiring per IEC standard

⑦ 50/60 Hz coils for CAB6-140 contactor not available

 ⑧ Extended operating limits $0.65...1.3 \times U_s$

 ⑨ Extended operating limits $0.7...1.25 \times U_s$

Contactors

Product Selection

Safety Contactors



- AC / DC control
- 3 / 4 main contacts
- Positively guided contacts according to IEC 947-5-1
- Mechanically coupled Contactor and Auxiliary contact block
- Protection against unintended actuation
- Auxiliary contacts are electronically compatible according to DIN 19240

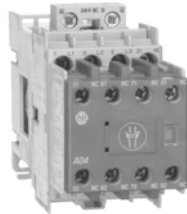

With 3 Main Contacts

AC-1 (40°C)	Switching of 3-phase Motors AC-2, AC-3, AC-4 (60 °C)								Positively Guided Auxiliary Contacts		Cat. No.	PQ
	[kW] Ⓢ				[A]							
[A]	230 V	400 / 415 V	500 V	690 V	230 V	400 / 415 V	500 V	690 V				
32	3	4	4	4	11.5	9	7	5	0	5	100S-C09Ⓢ05C	1
									1	4	100S-C09Ⓢ14C	
									2	3	100S-C09Ⓢ23C	
32	4	5.5	5.5	5.5	14.5	12	10	7	0	5	100S-C12Ⓢ05C	1
									1	4	100S-C12Ⓢ14C	
									2	3	100S-C12Ⓢ23C	
32	5.5	7.5	7.5	7.5	20	16 / 15	13	9.3	0	5	100S-C16Ⓢ05C	1
									1	4	100S-C16Ⓢ14C	
									2	3	100S-C16Ⓢ23C	
32	7.5	11	11	10	24	23 / 22	18	12	0	5	100S-C23Ⓢ05C	1
									1	4	100S-C23Ⓢ14C	
									2	3	100S-C23Ⓢ23C	
50	10	15	15	15	34	30 / 29	24	17	0	4	100S-C30Ⓢ04C	1
									2	2	100S-C30Ⓢ22C	
50	11	18.5	18.5	18.5	37	37 / 36	30	20	0	4	100S-C37Ⓢ04C	1
									2	2	100S-C37Ⓢ22C	
85	13	22	22	22	42	43 / 41	34	25	0	4	100S-C43Ⓢ04C	1
									2	2	100S-C43Ⓢ22C	
100	18.5	30	30	30	62	60 / 58	45	34	0	4	100S-C60Ⓢ04C	1
									2	2	100S-C60Ⓢ22C	
100	22	37	37	37	70	72 / 69	56	42	0	4	100S-C72Ⓢ04C	1
									2	2	100S-C72Ⓢ22C	
100	25	45	45	45	85	85 / 82	67	49	0	4	100S-C85Ⓢ04C	1
									2	2	100S-C85Ⓢ22C	

With 4 Main Contacts

AC-1 (40°C)	Switching of 3-phase Motors AC-2, AC-3, AC-4 (60 °C)								Positively Guided Auxiliary Contacts		Cat. No.	PQ
	[kW] Ⓢ				[A]							
[A]	230 V	400 / 415 V	500 V	690 V	230 V	400 / 415 V	500 V	690 V				
32	7.5	11	11	10	24	23 / 22	18	12	0	4	100S-C23Ⓢ404C	1
									0	4	100S-C23Ⓢ304C	
									2	2	100S-C23Ⓢ422C	
									2	2	100S-C23Ⓢ322C	

PQ = Package Quantity

Accessories - Page 4-24
 Specifications - Page 4-36
 Dimensions - Page 4-61



Reversing-Safety Contactors

- AC / DC control
- 3 main contacts, coil connections above
- Positively guided contacts acc. to IEC 947-5-1
- Mechanically coupled Contactor and Auxiliary contact block
- Protection against unintended actuation
- Auxiliary contacts are electronically compatible according
- to DIN 19240
- Mechanical / Electrical interlock included
- Wiring set for main pole interconnection included



4

With 3 Main Contacts

AC-1 (40°C)	Switching of 3-phase Motors AC-2, AC-3, AC-4 (60 °C)								Positively Guided Aux. contact per Contactor			Cat. No.	PQ
	[kW] ①				[A]								
[A]	230 V	400 / 415 V	500 V	690 V	230 V	400 / 415 V	500 V	690 V					
32	3	4	4	4	11.5	9	7	5	0	5	②	104S-C09②012C	1
									0	5		104S-C09②010C	
32	4	5.5	5.5	5.5	14.5	12	10	7	0	5	②	104S-C12②012C	
									0	5		104S-C12②010C	
32	5.5	7.5	7.5	7.5	20	16 / 15	13	9.3	0	5	②	104S-C16②012C	
									0	5		104S-C16②010C	
32	7.5	11	11	10	24	23 / 22	18	12	0	5	②	104S-C23②012C	
									0	5		104S-C23②010C	
50	10	15	15	15	34	30 / 29	24	17	0	4	②	104S-C30②010C	
									0	4		104S-C30②008C	
50	11	18.5	18.5	18.5	37	37 / 36	30	20	0	4	②	104S-C37②010C	
									0	4		104S-C37②008C	
85	13	22	22	22	42	43 / 41	34	25	0	4	②	104S-C43②010C	
									0	4		104S-C43②008C	
100	18.5	30	30	30	62	60 / 58	45	34	0	4	②	104S-C60②010C	
									0	4		104S-C60②008C	
100	22	37	37	37	70	72 / 69	56	42	0	4	②	104S-C72②010C	
									0	4		104S-C72②008C	
100	25	45	45	45	85	85 / 82	67	49	0	4	②	104S-C85②010C	
									0	4		104S-C85②008C	

⊗ Voltage Suffix Codes for AC Control

100S-C, 104S-C	[V]	12	24	32	36	42	48	100	100-110	110	120	127	200	200-220	200-230	208-240
	50 Hz	(R)	(K)	(V)	(W)	(X)	(Y)	(KP)	—	(D)	(P)	(S)	(KG)	—	—	—
	60 Hz	(Q)	(J)	—	(V)	—	(X)	—	(KP)	—	(D)	—	—	(KG)	—	(L)
	50/60 Hz	—	KJ	—	—	—	KY	(KP)	—	KD	—	—	(KG)	—	(KL)	—
	[V]	220-230	230	230-240	240	277	347	380	380-400	400	400-415	440	480	500	550	600
50 Hz	(F)	—	(VA)	(T)	—	—	—	—	(N)	—	(G)	(B)	—	(M)	(C)	—
60 Hz	—	—	—	(A)	(T)	(I)	(E)	—	—	—	(N)	(B)	—	—	(C)	—
50/60 Hz	—	KF	—	(KA)	—	—	—	—	—	KN	—	(KB)	—	—	—	—

⊗ Voltage Suffix Codes for DC Control

100S-C09...C43, 104S-C09...C43	[V]	9 ②	12	24 ②	36	48	60	64	72	80	110	115	125	220	230	250
	DC	(ZR)	(ZQ)	ZJ	(ZW)	(ZY)	(ZZ)	(ZB)	(ZG)	(ZE)	ZD	(ZP)	(ZS)	(ZA)	(ZF)	(ZT)
with diode protection circuit	DC	—	—	DJ	—	—	—	—	—	—	—	—	—	—	—	—
100S-C60...C85, 104S-C60...C85	DC	—	—	—	—	—	—	—	—	—	—	—	—	—	—	—
with diode protection circuit	DC	(DR)	(DQ)	DJ	(DW)	(DY)	(DZ)	(DB)	(DG)	(DE)	DD	(DP)	(DS)	(DA)	(DF)	(DT)

Price Adder for:	Type	Available Control Voltages	No Surcharge
Special control voltages	100S-C, 104S-C	12...600 V 50 Hz, 12...600 V 60 Hz, 12...250 VDC	> 20 pieces

() Control voltages in parentheses: No inventory

① Power ratings: Preferred values according to IEC 60072-1

② With mechanical and electrical locking 100-MCA02

③ Extended operating limits $0.65...1.3 \times U_s$

④ Extended operating limits $0.7...1.25 \times U_s$

Accessories - Page 4-24
Specifications - Page 4-36
Dimensions - Page 4-61

Contactors

Assignment of Contacts

Contactors with 3 Main Contacts

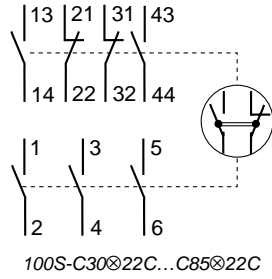
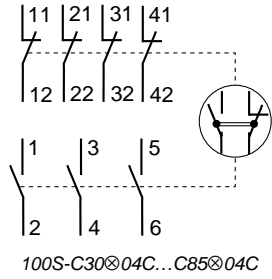
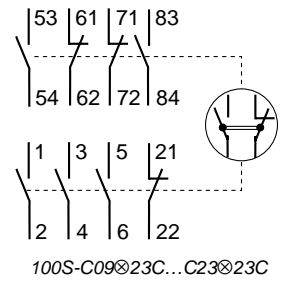
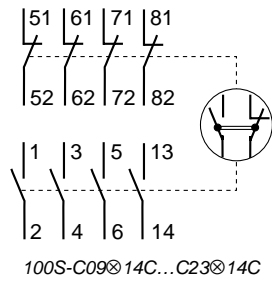
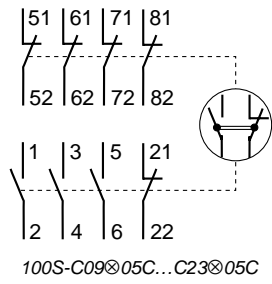

Contactors with 4 Main Contacts

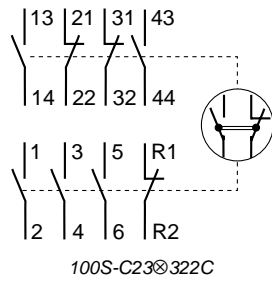
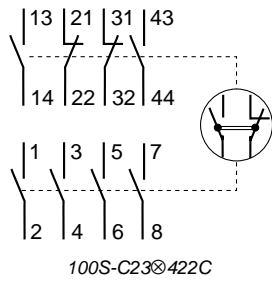
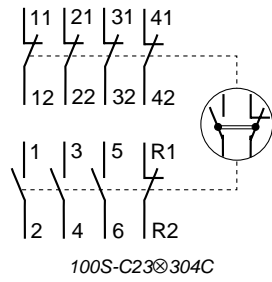
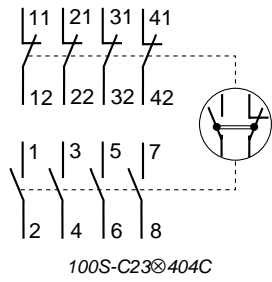

Reversing-Safety Contactors with 3 Main Contacts

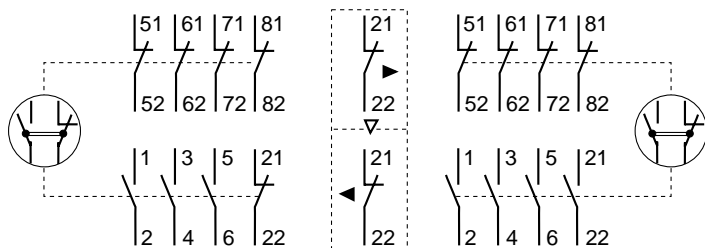

104S-C09⊗012C...C23⊗012C

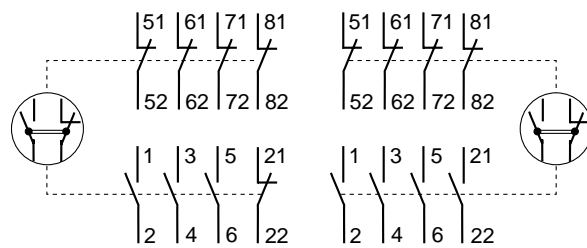

104S-C09⊗010C...C23⊗010C

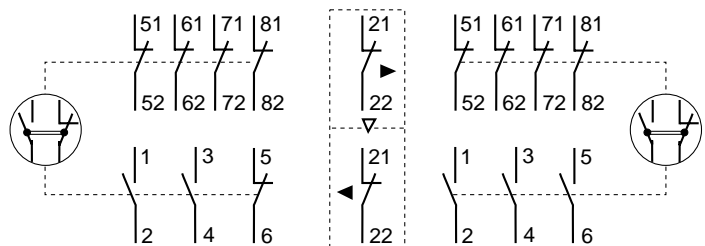

104S-C30⊗010C...C85⊗010C

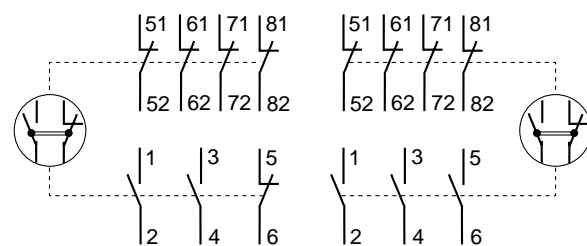

104S-C30⊗008C...C85⊗008C

Contactors

Assignment of Contacts

Device Combinations in Accordance with EN Standards

Auxiliary Contact Blocks		Contactors 100-C (AC / DC Control)						
Circuit Diagram	Control	100-C09⊕⊕10 100-C12⊕⊕10 100-C16⊕⊕10 100-C23⊕⊕10	100-C09⊕⊕01 100-C12⊕⊕01 100-C16⊕⊕01 100-C23⊕⊕01	100-C30⊕⊕00 100-C37⊕⊕00 100-C43⊕⊕00 100-C60⊕⊕00 100-C72⊕⊕00 100-C85⊕⊕00	100-C23⊕⊕400	100-C23⊕⊕300	100-C23⊕⊕200	
Front-mounted ①								
100-FA02		AC / DC	10 + 02 = 12	01 + 02 = 03	00 + 02 = 02	00 + 02 = 02	00 + 02 = 02	00 + 02 = 02
100-FA11		AC / DC	10 + 11 = 21	01 + 11 = 12	00 + 11 = 11	00 + 11 = 11	00 + 11 = 11	00 + 11 = 11
100-FB11		AC / DC	—	—	00 + 11 = 11	00 + 11 = 11	00 + 11 = 11	00 + 11 = 11
100-FC11		AC / DC	10 + 11 = 21	01 + 11 = 12	—	—	—	—
100-FA20		AC / DC	10 + 20 = 30	01 + 20 = 21	00 + 20 = 20	00 + 20 = 20	00 + 20 = 20	00 + 20 = 20
100-FBL11		② AC / DC	—	—	00 + 11 = 11	00 + 11 = 11	00 + 11 = 11	00 + 11 = 11
100-FA22		AC / DC	10 + 22 = 32	01 + 22 = 23	00 + 22 = 22	00 + 22 = 22	00 + 22 = 22	00 + 22 = 22
100-FB22		AC / DC	—	—	00 + 22 = 22	00 + 22 = 22	00 + 22 = 22	00 + 22 = 22
100-FC22		AC / DC	10 + 22 = 32	—	—	—	—	—
100-FA31		AC / DC	10 + 31 = 41	01 + 31 = 32	00 + 31 = 31	00 + 31 = 31	00 + 31 = 31	00 + 31 = 31
100-FA40		AC / DC	10 + 40 = 50	01 + 40 = 41	00 + 40 = 40	00 + 40 = 40	00 + 40 = 40	00 + 40 = 40
100-FAL22		② AC / DC	10 + 22 = 32	01 + 22 = 23	00 + 22 = 22	00 + 22 = 22	00 + 22 = 22	00 + 22 = 22
Side-mounted ①								
100-SB01		AC / DC	10 + 01 = 11	01 + 01 = 02 ③	00 + 01 = 01	00 + 01 = 01	00 + 01 = 01	00 + 01 = 01
100-SB10		AC / DC	10 + 10 = 20 ③	01 + 10 = 11	00 + 10 = 10	00 + 10 = 10	00 + 10 = 10	00 + 10 = 10
100-SB02		AC / DC	10 + 02 = 12 ③	—	00 + 02 = 02	00 + 02 = 02	00 + 02 = 02	00 + 02 = 02
100-SB11		AC / DC	10 + 11 = 21 ③	01 + 11 = 12 ③	00 + 11 = 11	00 + 11 = 11	00 + 11 = 11	00 + 11 = 11
100-SB20		AC / DC	10 + 20 = 30 ③	01 + 20 = 21 ③	00 + 20 = 20	00 + 20 = 20	00 + 20 = 20	00 + 20 = 20
100-SBL11		② AC / DC	10 + 11 = 21 ③	01 + 11 = 12 ③	00 + 11 = 11	00 + 11 = 11	00 + 11 = 11	00 + 11 = 11

4

Device Combinations in Accordance with EN Standards

Auxiliary Contact Block		Miniature Contactor 100-M (AC / DC Control)					
Circuit Diagram	Control	100-M05N⊗3 100-M09N⊗3 100-M12N⊗3	100-M09N⊗4	100-M05N⊗31 100-M09N⊗31 100-M12N⊗31			
Front-mounted							
195-MB02		AC / DC	10 + 02 = 12	40 + 02 = 42	—		
195-MB11		AC / DC	10 + 11 = 21	40 + 11 = 51	—		
195-MA20		AC / DC	10 + 20 = 30	40 + 20 = 60	01 + 20 = 21		
195-MB22		AC / DC	10 + 22 = 32	40 + 22 = 62	—		
195-MA40		AC / DC	10 + 40 = 50	40 + 40 = 80	01 + 40 = 41		

Auxiliary Contact Block		Contactors CAB6 (AC / DC Control)							
Circuit Diagram	Control	CAB6-85-00⊗ CAB6-105-00⊗ CAB6-140-00⊗	CAB6-85-11⊗ CAB6-105-11⊗ CAB6-140-11⊗	CAB6-85-L11⊗ CAB6-105-L11⊗ CAB6-140-L11⊗	CAB6-85-L22⊗ CAB6-105-L22⊗ CAB6-140-L22⊗	CAB6-140-EI-00⊗ CAB6-170-EI-00⊗ CAB6-210-EI-00⊗ CAB6-250-EI-00⊗ CAB6-300-EI-00⊗ CAB6-420-EI-00⊗	CAB6-140-EI-11⊗ CAB6-170-EI-11⊗ CAB6-210-EI-11⊗ CAB6-250-EI-11⊗ CAB6-300-EI-11⊗ CAB6-420-EI-11⊗		
Right-side mounted									
CAB6-P2-11		AC DC AC / DC	00 + 11 = 11 — —	11 + 11 = 22 — —	— — 11 + 11 = 22	— — 22 + 11 = 33	— — 00 + 11 = 11	— — 11 + 11 = 22	
CAB6-P4-11		AC DC AC / DC	00 + 11 = 11 — —	11 + 11 = 22 — —	— — 11 + 11 = 22	— — 22 + 11 = 33	— — 00 + 11 = 11	— — 11 + 11 = 22	
CAB6-P2-L11		AC DC AC / DC	00 + 11 = 11 — —	11 + 11 = 22 — —	— — 11 + 11 = 22	— — 22 + 11 = 33	— — 00 + 11 = 11	— — 11 + 11 = L22	
CAB6-P2-B11		AC DC AC / DC	00 + 11 = 11 — —	11 + 11 = 22 — —	— — 11 + 11 = 22	— — 22 + 11 = 33	— — 00 + 11 = 11	— — 11 + 11 = 22	
Left-side mounted									
CAB6-P1-11		AC DC AC / DC	00 + 11 = 11 — —	11 + 11 = 22 — —	— — 11 + 11 = 22	— — 22 + 11 = 33	— — 00 + 11 = 11	— — 11 + 11 = 22	
CAB6-P3-11		AC DC AC / DC	00 + 11 = 11 — —	11 + 11 = 22 — —	— — 11 + 11 = 22	— — 22 + 11 = 33	— — 00 + 11 = 11	— — 11 + 11 = 22	
CAB6-P3-B11		AC DC AC / DC	00 + 11 = 11 — —	11 + 11 = 22 — —	— — 11 + 11 = 22	— — 22 + 11 = 33	— — 00 + 11 = 11	— — 11 + 11 = 22	

❶ Up to 8 auxiliary contacts possible: **Contactor + Front-mounted** (AC max. 4 N.C./DC max. 4 N.C.), **Side-mounted** (AC max. 2 N.O./DC max. 2 N.O. and max. 2 N.C.)

❷ Early make and/or late break

❸ **Double numbering:** Because of double numbering only left-side mounting is recommended

❹ Electronically suited auxiliary contact block

Contactors

Accessories

Modules: Auxiliary Contact Blocks

4

















- Auxiliary Contact Blocks for Front Mounting**
- 2- and 4-pole
 - Simple and quick attachment - no tools needed
 - Electronically compatible H-contacts
 - Contacts themselves in auxiliary contact block positively guided
 - Types with the same functions with several connection numbering variants

	Description	Circuit Diagram	For Use with	Cat. No.	PQ
	Auxiliary Contact Blocks for Front Mounting <ul style="list-style-type: none"> • 2- and 4-pole • Simple and quick attachment - no tools needed • Electronically compatible H-contacts • Contacts themselves in auxiliary contact block positively guided • Types with the same functions with several connection numbering variants 		100-M...3	195-MB02	10
			100-M	195-MB11	
			100-M	195-MA20	
			100-M...3, 100-M...4	195-MB22	
			100-M	195-MA40	
	Auxiliary Contact Blocks for Front Mounting ① <ul style="list-style-type: none"> • 2- and 4-pole • Simple and quick attachment - no tools needed • Electronically compatible contacts • Positive guidance in auxiliary and with main contactor poles (excluding type L) • Types with the same functions with several connection numbering variants L = Early Make/Late Break		100-C	100-FA02	★
			100-C	100-FA11	★
			C30×00...C85×00	100-FB11	★
			C09×10...C23×10	100-FC11	★
			100-C	100-FA20	★
			C30×00...C85×00	100-FBL11	★
			100-C	100-FA22	★
			C09×10...C23×10	100-FC22	★
			C30×00...C85×00	100-FB22	★
			100-C	100-FA31	★
			100-C	100-FA40	★
			100-C	100-FAL22	★

PQ = Package Quantity

Modules: Auxiliary Contact Blocks

	Description	Circuit Diagram	For Use with	Cat. No.	PQ
 Auxiliary Contact Blocks for Side Mounting <ul style="list-style-type: none"> • 1- and 2-pole • Dual numbering for left- or right-side mounting on contactor • Simple and quick attachment - no tools needed • Electronically compatible contacts • Positive guidance in auxiliary and with main contactor poles (excluding type L) L = Early Make/Late Break			100-C	100-SB01	★
			100-C, 100S-C ②	100-SB10	★
			100-C ②	100-SB02	★
			100-C ②	100-SB11	★
			100-C, 100S-C ②	100-SB20	★
			100-C ②	100-SBL11	★
 Auxiliary Contact Blocks <ul style="list-style-type: none"> • Up to 4 auxiliary contact blocks per contactor: P1 and P3 left, P2 and P4 right • With mechanical interlock — 2 auxiliary contact blocks per contactor, 1 left and 1 right • No change of base dimensions with 1 auxiliary contact block on each side 			CAB6 Left-side mounting	CAB6-P1-11	10
			CAB6 Right-side mounting	CAB6-P2-11	
			CAB6 Left-side mounting	CAB6-P3-11	
			CAB6 Right-side mounting	CAB6-P4-11	
			CAB6 Right-side mounting	CAB6-P2-L11	
	• Electronically compatible auxiliary contacts AC-1 250 V 0.1 A AC-15, DC-13 3 ... 125 V 1 ... 100 mA		CAB6 Right-side mounting	CAB6-P2-B11	
			CAB6 Left-side mounting	CAB6-P3-B11	

Options	Cat. No. Suffix	Description	Ordering Example
★ Package quantity	No Entry	⊆ Single pack (1 piece, standard quantity)	100-SB10.
	M	⊆ Multi-pack (10 pieces)	100-SB10M

① Up to 8 auxiliary contacts possible: **Contactor + Front-mounted** (AC max. 4 N.C./DC max. 4 N.C.), **Side-mounted** (AC max. 2 N.O./DC max. 2 N.O. and max. 2 N.C.)
 ② **Double numbering:** Because of double numbering 100-C09 ... 100-C23 only left-side mounting is recommended

PQ = Package Quantity

Contactors

Accessories





Modules: Timer

4

	Description	For Use with	Cat. No.	PQ	
	<p>Electronic Star-Delta Timing Relay Output Y picks up when the supply voltage is applied and resets again after time t. After a fixed changeover time t_u output relay Δ picks up and remains energised until the supply voltage is interrupted.</p>				
	<p>• 22.5 mm width</p> <p>Supply Voltage (A1/A2) U23 24...48 VDC 24...240 VAC, 50/60 Hz A40 346...440 VAC, 50/60 Hz</p> <p>Circuit Diagram</p> <p>Single Selectable Timing Range Use the catalogue number with the appropriate code.</p> <p>Timing range \odot</p> <p>C 0.5...10 s D 1.5...30 s E 0.05...1 min F 0.15...3 min G 0.5...10 min</p>	100-M, 100-C, CAB6	700-FSY2 \odot U23 on request: 700-FSY2 \odot A40	1	
	<p>• 17.5 mm width</p> <p>Supply Voltage (A1/A2) U23 24...48 VDC 24...240 VAC, 50/60 Hz</p> <p>Circuit Diagram</p> <p>Multiple Adjustable Timing Ranges 0.15 s...10 min (3s) 0.15...3 s (10s) 0.5...10 s (1mn) 0.05...1 min (10mn) 0.5...10 min</p>	100-M, 100-C, CAB6	700-FEY2QU23	1	
	<p>Timer After the set time has elapsed, the timer operates and the contactor in series is energised.</p>		<p>Pick-up Delay</p> <p>1...3 s 1...30 s</p> <p>100-M with 110...250 V 50/60 Hz / 110...250 VDC</p>	196-MT3S 196-MT30S	10
	<p>Timer for Y-Δ Switching After the set time has elapsed, the K3 contactor (Y) is de-energised and then after a time of 90 ± 30 ms the K2 contactor (Δ) is energised.</p>		<p>Setting Time Y Contactor 1...30 s</p> <p>100-M with 110...120 V 50/60 Hz</p>	196-MTSDA1	10
		<p>1...30 s</p> <p>100-M with 220...250 V 50/60 Hz</p>	196-MTSDA2		
		<p>1...30 s</p> <p>100-M with 48 V 50/60 Hz</p>	196-MTSDA3		
	<p>Pneumatic Timer Pneumatic timing contacts switch after the set time; the contacts on the main contactor operate without delay.</p> <p>• Continuous adjustment range</p>		<p>Pick-up Delay 0.3...30 s 1.8...180 s</p> <p>100-C with AC control</p>	100-FPTA30 100-FPTA180	1
<p>Drop-out Delay 0.3...30 s 1.8...180 s</p> <p>All 100-C</p>	100-FPTB30 100-FPTB180				

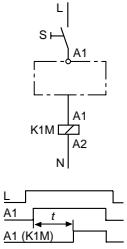
PQ = Package Quantity

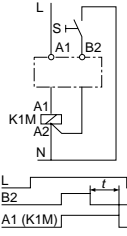
Modules: Timer

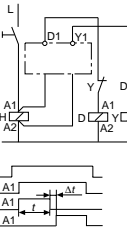





	Description	Circuit Diagram		For Use with	Cat. No.	PQ
	Electronic Timing Modules Delay of the contactor magnetic coil <ul style="list-style-type: none"> • Continuous adjustment range • High repeat accuracy 100-ETA The contact closes after the delay time elapses.		Pick-up Delay 0.1...3 s 1...30 s 10...180 s	100-C with 110...240 V 50/60 Hz 110...250 VDC	100-ETA3 100-ETA30 100-ETA180	1
				100-C with 24...48 VDC	100-ETAZJ3 100-ETAZJ30 100-ETAZJ180	
	100-ETB After interruption of the control signal, the contactor is switched off after the delay time elapses.		Drop-out Delay 0.3...3 s 1...30 s 10...180 s	100-C09...C37 with 24 V 50/60 Hz	100-ETBKJ3 100-ETBKJ30 100-ETBKJ180	1
				100-C with 110...240 V 50/60 Hz	100-ETB3 100-ETB30 100-ETB180	
	100-ETY After the set Y time elapses the K3 contact (Y) switches off and the K2 Contactor (Δ) switches on (Switching delay Δt 90 ms).		Setting Time Y Contactor 1...30 s	100-C with 110...240 V 50/60 Hz	100-ETY30	1

PQ = Package Quantity

Contactors

Accessories





Modules: Mechanical Interlocks

	Description	Circuit Diagram	For Use with	Cat. No.	PQ
	Mechanical Interlock <ul style="list-style-type: none"> For interlocking of two adjacent contactors Without additional space requirement attachable from rear and recessed in top hat rail 		100-M with AC control	199-MXM1	10
4 	Mechanical Interlock <ul style="list-style-type: none"> For interlocking of two adjacent contactors Mechanical and electrical interlock in one module possible by means of integrated auxiliary contacts Contactors with AC control: 100-C09...100-C85 and Contactors with DC control: 100-C60...100-C85 can be interlocked any way desired Attention: Contactors with DC-control: 100-C09...100-C43 can only be interlocked with contactors of the same type! 9 mm connection piece included 		100-C	100-MCA00	★
			100-C	100-MCA02	★
	Mechanical Interlock <ul style="list-style-type: none"> For interlocking of two adjacent contactors One component for the interlock of all Bulletin CAB6 contactors For mounting between two contactors; no additional space required 		CAB6	CMB6	10

Options	Cat. No. Suffix	Description	Ordering Example
★ Package quantity	No Entry	⊆ Single pack (1 piece, standard)	100-MCA00
	M	⊆ Multi-pack (10 pieces)	100-MCA00M

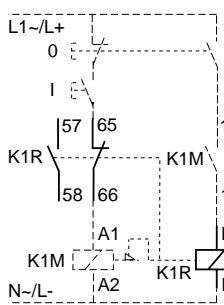
PQ = Package Quantity

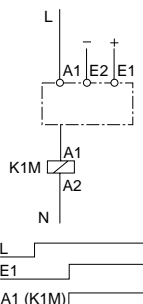
Modules

	Description	Circuit Diagram	For Use with	Cat. No.	PQ								
	<p>Mechanical Latch</p> <p>In latching contactors, the contactor coil is immediately switched off after the contact on the latch closes (65-66); consequently, no holding current flows. Can be used for both AC and DC operation</p> <ul style="list-style-type: none"> Auxiliary contacts 1 N.O. + 1 N.C. 		100-C with AC control	100-FL11⊗	1								
	<p>Interface (electronic)</p> <p>Interface between the DC control signal (PLC) and the contactor AC operating mechanism.</p> <ul style="list-style-type: none"> Control voltage 18...30 VDC (10...15 mA) For coil voltages of 110...240 VAC Suitable for all Bulletin 100-C contactors Switching capacity 200 VA Requires no overvoltage protection for the coils 	 <table border="1"> <thead> <tr> <th>Input</th> <th>Output</th> </tr> </thead> <tbody> <tr> <td>24 VDC</td> <td>110 ... 240 VAC</td> </tr> <tr> <td>12 VDC</td> <td></td> </tr> <tr> <td>48 VDC</td> <td></td> </tr> </tbody> </table>	Input	Output	24 VDC	110 ... 240 VAC	12 VDC		48 VDC		100-C, 100S-C with AC control	100-JE 100-JE12 100-JE48	★ ★ ★
Input	Output												
24 VDC	110 ... 240 VAC												
12 VDC													
48 VDC													
	<p>DeviceNet System Accessory Module</p> <ul style="list-style-type: none"> Includes complete terminal connector set Screw- or snap-on mounting to 35 mm DIN Rail EN 50 022 For product information, see chapter 15 (description, specifications and dimensions) 			120 V AC, 2 inputs 1 relay output 100-DNY21R 24 V DC, 2 inputs 1 relay output 100-DNY22R 24 V DC, 2 inputs 1 transistor output 100-DNY22S 120 V AC, 4 inputs 2 relay outputs 100-DNY41R 24 V DC, 4 inputs 2 relay outputs 100-DNY42R 24 V DC, 4 inputs 2 transistor outputs 100-DNY42S	1								

4

Options	Cat. No. Suffix	Description	Ordering Example
⊗ Voltage suffix code	e.g. KJ	Voltage suffix code from table below	100-FL11KJ
★ Package quantity	No Entry	△ Single pack (1 piece, standard)	100-JE
	M	△ Multi-pack (10 pieces)	100-JEM

⊗ Voltage Suffix Code for AC Control

100-FL11	[V]	12	24	32	36	42	48	100	100-110	110	120	127	200	200-220	200-230	208-240
	50 Hz	(R)	(K)	(V)	(W)	(X)	(Y)	(KP)	—	(D)	(P)	(S)	(KG)	—	—	—
60 Hz	(Q)	(J)	—	(V)	—	(X)	—	(KP)	—	(D)	—	—	(KG)	—	(L)	
50/60 Hz	—	KJ	—	—	—	KY	(KP)	—	KD	—	—	(KG)	—	(KL)	—	
100-FL11	[V]	220-230	230	230-240	240	277	347	380	380-400	400	400-415	440	480	500	550	600
	50 Hz	(F)	—	(VA)	(T)	—	—	—	(N)	—	(G)	(B)	—	(M)	(C)	—
	60 Hz	—	—	—	(A)	(T)	(I)	(E)	—	—	—	(N)	(B)	—	—	(C)
	50/60 Hz	—	KF	—	(KA)	—	—	—	—	KN	—	(KB)	—	—	—	—

Price Adder for:	Type	Available Control Voltages	No Surcharge
Special control voltages	100-FL11	12...500 V 50 Hz / 12...600 V 60 Hz	> 20 pieces

() Control voltages in parentheses: No inventory





PQ = Package Quantity

Contactors

Accessories

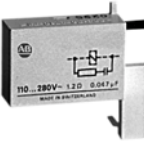
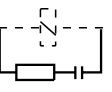
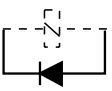
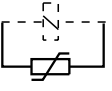

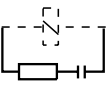
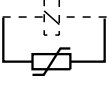
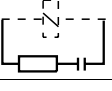

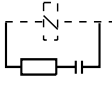



Modules: Suppressor Modules

4

	Description	Circuit Diagram		For Use with	Cat. No.	PQ		
	Suppressor Module for 100-M05 / M09/M12 Contactors For limiting surge voltage when coil circuits are interrupted.		RC Module AC control 24...48 VAC 110...240 VAC 24...48 VAC 110...280 VAC 380...480 VAC	2-wire version	199-MSMA48 199-MSMA1	10		
				100-M	199-MSMNA48 199-MSMNA280 199-MSMNA480			
				2-wire version	199-MSMD1			
			Diode Circuit DC control 12...250 VDC	100-M	199-MSMD2	10		
			Varistor Circuit AC/DC control 12...55 VAC / 12...77 VDC 56...136 VAC / 78...178 VDC 137...277 VAC / 181...350 VDC	100-M	199-MSMV4 199-MSMV5 199-MSMV6	10		
	Suppressor Module for 100-C Contactors For limiting switching overvoltage of the solenoids. <ul style="list-style-type: none"> Can be plugged into coil terminals of all 100-C contactors 		RC Module RC 24...48 VAC RC 110...280 VAC RC 380...480 VAC 24...48 V 50/60 Hz 110...280 V 50/60 Hz 380...480 V 50/60 Hz	2-wire version	100-FSC48W 100-FSC280W 100-FSC480W	★		
				100-C, 100S-C with AC control	100-FSC48 100-FSC280 100-FSC480	★		
				2-wire version	100-FSD250W	★		
				100-C, 100S-C with DC control	100-FSD250	★		
					Varistor Circuit 12...55 VAC / 12...77 VDC 56...136 VAC / 78...180 VDC 137...277 VAC / 181...350 VDC 278...575 VAC 12...55 VAC / 12...77 VDC 56...136 VAC / 78...180 VDC 137...277 VAC / 181...350 VDC 278...575 VAC	2-wire version	100-FSV55W 100-FSV136W 100-FSV277W 100-FSV575W	★
				100-C, 100S-C with AC / DC control	100-FSV55 100-FSV136 100-FSV277 100-FSV575	★		
		Contact Safety Control 24...250 VDC	All 100-C	100-FCC250W	★			
	Suppressor Module for CAB6 Contactors For limiting surge voltage when coil circuits are interrupted. <ul style="list-style-type: none"> Can be plugged into all CAB6 contactors Integrated EI- and DC control in the protective circuit, or delivered with separate suppressor module ⚠ For overvoltage category IV (IEC 947 for CAB6...-EI) e.g., lightning protection requirements		RC Module (AC control) 21...48 V 50 Hz / 24...55 V 60 Hz 95...110 V 50 Hz / 110...127 V 60 Hz 190...240 V 50 Hz / 220...277 V 60 Hz 380...550 V 50 Hz / 440...575 V 60 Hz	CAB6-85... CAB6-140	CRCB6-48 CRCB6-110 CRCB6-240 CRCB6-550	10		
				Varistor-Modul for contactors with conventional control ≤ 55 VAC 56...136 VAC 137...277 VAC 278...575 VAC	CAB6-85... CAB6-140	CRVB6-55 CRVB6-136 CRVB6-277 CRVB6-575		
				for contactors with electronic control 24...28 VAC	CAB6-105-EI... CAB6-250-EI	CRVB6-40		
				24...28 VDC	CAB6-105-EI... CAB6-300-EI			
				48...72 VDC 43...65 VAC 208...277 VAC ⚠ 380...400 VAC	CAB6-105-EI... CAB6-420-EI	CRVB6-55 CRVB6-75 CRVB6-550 CRVB6-460	10	

Options	Cat. No. Suffix	Description	Ordering Example
★ Package quantity	No Entry	⊆ Single pack (1 piece, standard)	100-FSC48
	M	⊆ Multi-pack (10 pieces)	100-FSC48M

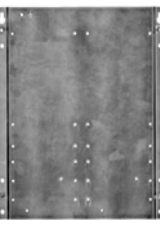
Mounting Materials

	Description	Cat. No.	PQ	
	Adapter <ul style="list-style-type: none"> For easy, toolless mounting of timers on to DIN Rails EN 50 022-35 and G Rails 	196-MTM	10	
	Connection Pieces <ul style="list-style-type: none"> To link contactors (100-C) into combinations 	Single wedge 0 mm Wedge-type connector 9 mm	100-S0 100-S9	10
	Terminal Blocks <ul style="list-style-type: none"> Set of 2 Protection class IP20 per IEC 529 and DIN 40 050 	For CAB6-85 / CAB6-105 For CAB6-105-EI / CAB6-170-EI For CAB6-210-EI...CAB6-420-EI	CAB6-HB1 CAB6-HB2 CAB6-HB3	1
	Terminal Blocks UL / CSA <ul style="list-style-type: none"> Set of 3 	For CAB6-85, CAB6-105 For CAB6-140, CAB6-105-EI...CAB6-170-EI For CAB6-210-EI, CAB6-250-EI, CAB6-300-EI, CAB6-420-EI	CAB6-105-HU CAB6-170-HU 825-ML630	1
	Control Circuit Terminal <ul style="list-style-type: none"> 2 x 2.5 mm² 	For connecting to CAB6-85...170-EI For connecting to CAB6-210-EI...420-EI	CAB6-AT CAB6-AT2	10
	Single Covers <ul style="list-style-type: none"> Set of 2 Protection class IP10 per IEC 529 and DIN 40 050 	For CAB6-85, CAB6-105 For CAB6-140, CAB6-105-EI...CAB6-170-EI For CAB6-210-EI...CAB6-420-EI	CAB6-HA1 CAB6-HA2 CAB6-HA3	1
	Mounting Plate <ul style="list-style-type: none"> Galvanised passivated steel plate for combination 	For CAB6-85...CAB6-170-EI For direct-on-line starter For reversing or two-speed starters For Y-Δ or Dahlander starters	CAB6-105-PS CAB6-105-PU CAB6-105-PY	1
		For CAB6-210-EI...CAB6-420-EI For direct-on-line starter For reversing or two-speed starters For Y-Δ or Dahlander starters	CAB6-250-PS CAB6-250-PU CAB6-250-PY	
	Cover to Protect against Manual Operation <ul style="list-style-type: none"> Protection against unintended manual operation For contactors and auxiliary contacts in safety circuits 	For 100-C09..100-C85 For 100-FA, 100-FB, 100-FC, 100-FP, 100-FL	100-SCC 100-SCF	★





PQ = Package Quantity

Contactors

Accessories

Mounting Materials



4

	Description	For Use with	Cat. No.	PQ
 <p>Connection Modules</p> <ul style="list-style-type: none"> The connection module allows a safe and easy electrical and mechanical connection of contactor and circuit breaker For DOL, reversing, and star-delta starters 	Connects: Bulletin 140-M-C circuit breakers with Bulletin 100-M miniature contactors		140M-C-PEM12	★
	Connects: Bulletin 140-MN circuit breakers with Bulletin 100-M miniature contactors		140-KCD4	10
	Connects: Bulletin 140-MN circuit breakers with Bulletin 100-C contactors		140-NW23	★
 <p>Enclosures</p> <p>For Bulletin 100-C contactors with Bulletin overload relays 193-E</p> <ul style="list-style-type: none"> For DOL starters Protection Class IP66 Prestampings for two pilot lights 	Without buttons	100-C09...C23	198E-AYMN2	
	With blue RESET button	100-C09...C23	198E-AYMU1	1
	With green and red buttons: START / STOP, RESET		198E-AYMU2	
	With green and extended red buttons: START / STOP, RESET		198E-AYMU4	
	With blue RESET button	100-C30...C37	198E-AYNU1	
	With green and red buttons: START / STOP, RESET		198E-AYNU2	
With green and extended red buttons: START / STOP, RESET		198E-AYNU4		
With white and black buttons: START / STOP, RESET	100-C09...C23	198E-AYMU3		
With white and extended black buttons: START / STOP, RESET		198E-AYMU5		
With white and black buttons: START / STOP, RESET	100-C30...C37	198E-AYNU3		
With white and extended black buttons: START / STOP, RESET		198E-AYNU5		
 <p>Pilot Light</p> <ul style="list-style-type: none"> Mounting with plug-in coupling in upper enclosure part Connection cable length 180 mm Incl. glow lamp 	red 120 V	198E-AY	140-LR120	10
	240 V		140-LR240	
	400 V		140-LR400	
	green 120 V		140-LG120	
	240 V		140-LG240	
	400 V		140-LG400	
white 120 V	140-LW120			
240 V	140-LW240			
400 V	140-LW400			
 <p>Auxiliary Contact (START)</p> <ul style="list-style-type: none"> For use with Cat. No. 198E-AY... enclosure 		100-C	100-SD10	★

Options	Cat. No. Suffix	Description	Ordering Example
★ Package quantity	No Entry	⊆ Single pack (1 piece, standard quantity)	140M-C-PEM12
	M	⊆ Multi-pack (20 pieces)	140M-C-PEM12 M
⊕ Package quantity	No Entry	⊆ Single pack (1 piece, standard quantity)	100-SD10
	M	⊆ Multi-pack (10 pieces)	100-SD10 M

PQ = Package Quantity

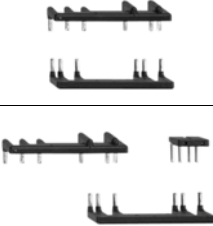

Mounting Materials

	Description	Cat. No.	PQ	
Connection Kits				
Connection kits ease the wiring of reversing and star-delta starters, help to prevent wiring errors and therefore considerably contribute to cost minimizing.				
	Connection Kits <ul style="list-style-type: none"> For reversing switching For star-delta switching 	Reversing switching 100-M Star-Delta switching 100-M	140-KCR4 140-KCSD4	10
		Connection Kits <ul style="list-style-type: none"> For reversing switching For star-delta switching 	Reversing switching 100-C09...100-C23 100-C30...100-C37 100-C43 100-C60...100-C85 Star-Delta switching 100-C09...100-C23 100-C30...100-C37 100-C43 100-C60...100-C72 100-C85	105-PW23 105-PW37 105-PW43 105-PW85 170-PW23 170-PW37 170-PW43 170-PW72 170-PW85
		Connecting Sets	For Bulletin CAB6-85 ... CAB6-170-EI Contactors 45 mm ² input connections (for CAB6-..HU) 50 mm ² input connections (for CAB6-..HB) 45 mm ² output connections (for CAB6-..HU) 50 mm ² output connections (for CAB6-..HB) «Neutral bridge» for CAB6-85...CAB6-170-EI	CAB6-105-VLHU CAB6-105-VLHB CAB6-105-VT CAB6-105-VTHB CAB6-105-VYU
	For Bulletin CAB6-210-EI ... CAB6-420-EI Contactors 120 mm ² input connections (for CAB6-..HB3 and CAB6-..HU) 120 mm ² output connections (for CAB6-..HU) 120 mm ² output connections (for CAB6-..HB) For Y-contactor CAB6-140-EI...CAB6-170-EI; 80 mm ² For Y-contactor CAB6-210-EI...CAB6-250-EI; 120 mm ² For Y-contactor CAB6-210-EI...CAB6-250-EI; 120 mm ² (for CAB6-..HB) «Neutral bridge» for CAB6-210-EI...CAB6-420-EI		CAB6-250-VL CAB6-250-VT CAB6-250-VTHB CAB6-250-VY CAB6-250-VT CAB6-250-VTHB CAB6-250-VYU	

Labelling Material

	<ul style="list-style-type: none"> Uniform labelling materials for contactors, motor protection devices, timing relays, and circuit breakers Product information and ordering statements see chapter 3
---	---

Renewal Parts

	Description	For Use with	Cat. No.	PQ
	Arc Chambers for Contactors <ul style="list-style-type: none"> For 3-Pole CAB6 contactors 	CAB6-85 CAB6-105 CAB6-105-EI CAB6-140-EI CAB6-170-EI CAB6-210-EI CAB6-250-EI CAB6-300-EI CAB6-420-EI	CAB6-85-ARC CAB6-105-ARC CAB6-105-EI-ARC CAB6-140-EI-ARC CAB6-170-EI-ARC CAB6-210-EI-ARC CAB6-250-EI-ARC CAB6-300-EI-ARC CAB6-420-EI-ARC	1
	Main Contacts for Contactors <ul style="list-style-type: none"> Set for 3-Pole CAB6 contactors 	CAB6-85 CAB6-105 CAB6-105-EI CAB6-140 CAB6-140-EI CAB6-170-EI CAB6-210-EI CAB6-250-EI CAB6-300-EI CAB6-420-EI	CAB6-85-CONT-1 CAB6-105-CONT-2 CAB6-105-EI-CONT-22 CAB6-140-CONT-33 CAB6-140-EI-CONT-3 CAB6-170-EI-CONT-4 CAB6-210-EI-CONT-5 CAB6-250-EI-CONT-6 CAB6-300-EI-CONT-7 CAB6-420-EI-CONT-8	1

Contactors

Accessories

Renewal Parts: Coils for Bulletin 100-C, 100S-C Contactors



4

AC Control Voltage	60 Hz	50/60 Hz	AC Coil Code	100-C09... 100-C16	100-C23... 100-C37	100-C43	100-C60... 100-C85	DC Control Voltage	DC Coil Code	100-C09... 100-C16	100-C23... 100-C37	100-C43	100-C60... 100-C85
				PQ = 10		PQ = 1				PQ = 10		PQ = 1	
				Cat. No.	Cat. No.	Cat. No.	Cat. No.			Cat. No.	Cat. No.	Cat. No.	Cat. No.
50 Hz	12 V		Q	TA006	TC006	TD006	TE006	9 V ①	ZR	TA766	TC766-	TD766-	—
12 V			R	TA404	TC404	TD404	TE404		integr. diode	DR	—	—	—
	24 V		J	TA013	TC013	TD013	TE013	12 V	ZQ	TA708	TC708	TD708	—
24 V			K	TA407	TC407	TD407	TE407		integr. diode	DQ	—	—	—
		24 V	KJ	TA855	TC855	TD855	TE855	24 V ②	ZJ	TA714	TC714	TD714	—
32 V	36 V		V	TA481	TC481	TD481	TE481		integr. diode	DJ	TA714M	TC714M	TD714M
36 V			W	TA410	TC410	TD410	TE410	36 V	ZW	TA719	TC719	TD719	—
42 V	48 V		X	TA482	TC482	TD482	TE482		integr. diode	DW	—	—	—
48 V			Y	TA414	TC414	TD414	TE414	48 V	ZY	TA724	TC724	TD724	—
		48 V	KY	TA860	TC860	TD860	TE860		integr. diode	DY	—	—	—
100 V	100...110V		KP	TA861	TC861	TD861	TE861	60 V	ZZ	TA774	TC774	TD774	—
110 V	120 V		D	TA473	TC473	TD473	TE473		integr. diode	DZ	—	—	—
		110 V	KD	TA856	TC856	TD856	TE856	64 V	ZB	TA727	TC727	TD727	—
120 V			P	TA425	TC425	TD425	TE425		integr. diode	DB	—	—	—
127 V			S	TA428	TC428	TD428	TE428	72 V	ZG	TA728	TC728	TD728	—
200 V	200...220V		KG	TA862	TC862	TD862	TE862		integr. diode	DG	—	—	—
		200...230 V	KL	TA864	TC864	TD864	TE864	80 V	ZE	TA729	TC729	TD729	—
		208...240 V	L	TA296	TC296	TD296	TE296		integr. diode	DE	—	—	—
220 V	240 V		A	TA474	TC474	TD474	TE474	110 V	ZD	TA733	TC733	TD733	—
220...230 V			F	TA441	TC441	TD441	TE441		integr. diode	DD	—	—	—
		230 V	KF	TA851	TC851	TD851	TE851	115 V	ZP	TA734	TC734	TD734	—
230...240 V			VA	TA440	TC440	TD440	TE440		integr. diode	DP	—	—	—
240 V	277 V		T	TA480	TC480	TD480	TE480	125 V	ZS	TA737	TC737	TD737	—
		240 V	KA	TA858	TC858	TD858	TE858		integr. diode	DS	—	—	—
		347 V	I	TA065	TC065	TD065	TE065	220 V	ZA	TA747	TC747	TD747	—
		380 V	E	TA067	TC067	TD067	TE067		integr. diode	DA	—	—	—
380...400 V	440 V		N	TA071	TC071	TD071	TE071	230 V	ZF	TA749	TC749	TD749	—
		400 V	KN	TA863	TC863	TD863	TE863		diode circuit included	DF	—	—	—
400...415 V			G	TA457	TC457	TD457	TE457	250 V	ZD	TA751	TC751	TD751	—
440 V	480 V		B	TA475	TC475	TD475	TE475		diode circuit included	DT	—	—	—
		440 V	KB	TA859	TC859	TD859	TE859						
500 V			M	TA479	TC479	TD479	TE479						
550 V	600 V		C	TA476	TC476	TD476	TE476						

Price Adder for:	Type	Available Control Voltages	No Surcharge
Special control voltages	100-C09 ... 100-C85 For special voltages, please contact sales office	12...500 V 50 Hz, 12...600 V 60 Hz, 12 ... 250 VDC	> 20 pieces

① Extended operating limits 0.65...1.3 x U_s

② Extended operating limits 0.7...1.25 x U_s

PQ = Package Quantity

Renewal Parts: Coils and Supply Modules for Bulletin CAB6 Contactors

	Description	Variations	For Use with	Cat. No.	PQ
 <p>Set: Coils and Supply Modules for CAB6 Contactors For replacement only</p>		AC control			
		Conventional	CAB6-85...CAB6-140	CAB6-105-COIL-⊗	1
		Electronic ②	CAB6-105-EI...CAB6-250-EI (24...28 V 50/60 Hz)	CAB6-250-EI-COIL-05	
			CAB6-105-EI...CAB6-300-EI	CAB6-300-EI-COIL-⊗	
			CAB6-420-EI	CAB6-420-EI-COIL-⊗	
		DC control			
Conventional	CAB6-85...CAB6-140	CAB6-105-COIL-⊗			
Electronic ②	CAB6-105-EI...CAB6-300-EI	CAB6-300-EI-COIL-⊗			
	CAB6-420-EI	CAB6-420-EI-COIL-⊗			

Options	Cat. No. Suffix	Description	Ordering Example
⊗ Voltage suffix code	e.g. 54	Voltage suffix code from table below	CAB6-105-COIL- 54

⊗ Voltage Suffix Codes for AC Control

	[V]	24	28	48	55	110	127	220-230	230	240	260	277	380-400	415	440-460	480
CAB6-85...CAB6-140 ①	50 Hz	05	—	08	—	10	—	13	—	(15)	—	—	16	(17)	—	—
	60 Hz	—	05	—	08	—	10	—	—	—	13	(15)	—	—	16	(17)
	50/60 Hz	—	—	—	—	(48)	—	—	54	(55)	—	—	—	—	—	—
CAB6-105-EI...CAB6-250-EI		24-28	43-65	110-130	208-277	380-400										
	50/60 Hz	05	08	10	14	16										
CAB6-300-EI...CAB6-420-EI	50/60 Hz	—	08	10	14	16										

⊗ Voltage Suffix Codes for DC Control

	[V]	24	48	110	220											
CAB6-85...CAB6-140																
	DC	66	(70)	76	(86)											
CAB6-105-EI...CAB6-300-EI		24-28	48-72	90-135	110-135	170-255	190-255									
	DC	66	(70)	76	—	(86)	—									
CAB6-420-EI	DC	—	(70)	—	76	—	(86)									

Price Adder for:	Type	Available Control Voltages	No Surcharge
Special control voltages	CAB6-85...CAB6-140 ①	21...550 V 50 Hz, 24...575 V 60 Hz, 110...240 V 50/60 Hz, 24 ... 240 VDC	> 25 pieces

() Control voltages in parentheses: No inventory

① 50/60 Hz coil only available for CAB6-85 and 105

② Will be delivered only as set coil and supply module

PQ = Package Quantity

Contactors

Specifications

IEC Specifications

	100-M			100-C, 100S-C						
	05	09	12	09	12	16	23	30	37	
AC-1 Active Power Load, Switching of 3-phase Motors										
Ambient temperature 40 °C										
<i>I_e</i>	≤ 500 V [A]	20	20	20	32	32	32	32 (40) ①	50	50
	690 V [A]	—	—	—	32	32	32	32 (40) ①	50	50
	1000 V [A]	—	—	—	—	—	—	—	—	—
	230 V [kW]	8	8	8	13	13	13	13	20	20
	240 V [kW]	8.3	8.3	8.3	13	13	13	13	21	21
	400 V [kW]	14	14	14	22	22	22	22	35	35
	415 V [kW]	14	14	14	23	23	23	23	36	36
	500 V [kW]	17	17	17	28	28	28	28	43	43
	690 V [kW]	—	—	—	38	38	38	38	60	60
	1000 V [kW]	—	—	—	—	—	—	—	—	—
Ambient temperature 60 °C										
<i>I_e</i>	≤ 500 V [A]	16	16	16	32	32	32	32	45	45
	690 V [A]	—	—	—	32	32	32	32	45	45
	1000 V [A]	—	—	—	—	—	—	—	—	—
	230 V [kW]	6.4	6.4	6.4	13	13	13	13	18	18
	240 V [kW]	6.7	6.7	6.7	13	13	13	13	19	19
	400 V [kW]	11	11	11	22	22	22	22	31	31
	415 V [kW]	12	12	12	23	23	23	23	32	32
	500 V [kW]	14	14	14	28	28	28	28	39	39
	690 V [kW]	—	—	—	38	38	38	38	54	54
	1000 V [kW]	—	—	—	—	—	—	—	—	—
Switching of 3-phase Motors										
Ambient temperature 60 °C										
AC-2, AC-3, AC-4										
	230 V [A]	6.5	12	12	12	15	20	26.5	35	38
	240 V [A]	6.5	12	12	12	15	20	26.5	35	38
	400 V [A]	5.3	9	12 ②	9	12	16	23	30	37
	415 V [A]	5.3	9	12 ②	9	12	16	23	30	37
	500 V [A]	4	7	7	7	10	14	20	25	30
	690 V [A]	—	—	—	5	7	9	12	18	21
	1000 V [A]	—	—	—	—	—	—	—	—	—
	230 V ③ [kW]	1.5	3	3	3	4	5.5	7.5	10	11
	240 V ③ [kW]	1.5	3	3	3	4	5.5	7.5	10	11
	400 V ③ [kW]	2.2	4	5.5 ②	4	5.5	7.5	11	15	18.5
	415 V ③ [kW]	2.2	4	5.5 ②	4	5.5	7.5	11	15	20
	500 V ③ [kW]	2.2	4	4	4	5.5	7.5	13	15	20
	690 V ③ [kW]	—	—	—	4	5.5	7.5	10	15	18.5
	1000 V ③ [kW]	—	—	—	—	—	—	—	—	—
AC-4 at approximately 200 000 operations										
	230 V [A]	2.3	3.9	3.9	4.3	6.6	9	10	12	14
	240 V [A]	2.3	3.9	3.9	4.3	6.6	9	10	12	14
	400 / 415V [A]	2	3.3	3.3	4.3	6.6	9	10	12	14
	500 V [A]	1.9	3.2	3.2	4.3	6.6	9	10	12	14
	690 V [A]	—	—	—	4.3	6.6	9	10	12	14
	1000 V [A]	—	—	—	—	—	—	—	—	—
	230 V ③ [kW]	0.37	0.75	0.75	0.75	1.5	2.2	2.2	3	3.7
	240 V ③ [kW]	0.37	0.75	0.75	0.75	1.5	2.2	2.2	3	4
	400 V ③ [kW]	0.75	1.1	1.1	1.8	3	4	4	5.5	6.3
	415 V ③ [kW]	0.75	1.1	1.1	1.8	3	4	4	5.5	6.3
	500 V ③ [kW]	0.75	1.5	1.5	2.2	3.7	5.5	5.5	7.5	7.5
	690 V ③ [kW]	—	—	—	3	5.5	7.5	7.5	10	11
	1000 V ③ [kW]	—	—	—	—	—	—	—	—	—
	Max. switching frequency Sch/h	250	250	250	250	250	220	200	200	200

① Values in () with increased cross-section and cable lug

② Max. switching frequency

③ Power ratings: Preferred values according to IEC 60072-1

100-C, 100S-C				CAB6								
43	60	72	85	-85	-105(-EI)	-140	-140-EI	-170-EI	-210-EI	-250-EI	-300-EI	-420-EI
85	100	100	100	160	160	250	250	250	350	350	450	500
85	100	100	100	160	160	250	250	250	350	350	450	500
—	—	—	—	160	160	250	250	250	350	350	450	500
34	40	40	40	64	64	100	100	100	139	139	179	199
35	42	42	42	67	67	104	104	104	145	145	187	208
59	69	69	69	111	111	173	173	173	242	242	312	346
61	72	72	72	115	115	180	180	180	252	252	323	359
74	87	87	87	139	139	217	217	217	303	303	390	433
102	120	120	120	191	191	299	299	299	418	418	538	598
—	—	—	—	277	277	433	433	433	606	606	779	866
63	100	100	100	135	135	210	210	210	300	300	380	425
63	100	100	100	135	135	210	210	210	300	300	380	425
—	—	—	—	135	135	210	210	210	300	300	380	425
25	40	40	40	54	54	84	84	84	120	120	151	169
26	42	42	42	56	56	87	87	87	125	125	158	177
44	69	69	69	94	94	145	145	145	208	208	263	294
45	72	72	72	97	97	151	151	151	216	216	273	305
55	87	87	87	117	117	182	182	182	260	260	329	368
75	120	120	120	161	161	251	251	251	359	359	454	508
—	—	—	—	234	234	364	364	364	520	520	658	736
44	62	72	85	85	105	140	140	170	210	250	300	420
44	62	72	85	85	105	140	140	170	210	250	300	420
43	60	72	85	85	105	140	140	170	210	250	300	420
43	60	72	85	85 (95)④	105 (130)④	140 (155)④	140 (155)④	170	210 (227)④	250 (258)④	300 (315)④	420 (425)④
38	55	67	80	85	105	115	140	170	210	250	300	420②
25	34	42	49	85	105	115	140	170	210	250	300	420②
—	—	—	—	33	40	55	55	65	80	95	115	160
13	18.5	22	25	25	32	45	45	55	63	80	90	132
13	18.5	22	25	25	32	45	45	55	63	80	100	132
22	32	40	45	45	55	75	75	90	110	132	160	220
22	32	40	45	45 (55)④	55 (75)④	80 (90)④	80 (90)④	100	125 (132)④	150	160 (185)④	250
25	37	45	55	55	63	80	90	110	150	160	200	300 ⑤
22	32	40	45	80	100	110	132	160	200	250	300	425 ⑤
—	—	—	—	45	55	75	75	90	110	132	160	220
16.5	25.5	31	38	43	50	60	60	67	85	105	140	170
16.5	25.5	31	38	43	50	60	60	67	85	105	140	170
16.5	25.5	31	38	43	50	60	60	67	85	105	140	170
16.5	25.5	31	38	43	50	60	60	67	85	105	140	170
16.5	25.5	31	38	43	50	60	60	67	85	105	140	170
—	—	—	—	19	23	37	37	43	60	72	85	105
4	6.3	7.5	11	13	15	17	17	20	25	32	45	55
4	7.5	7.5	11	13	15	18.5	18.5	22	25	32	45	55
7.5	13	15	20	22	25	32	32	37	45	55	75	90
7.5	13	17	20	22	25	32	32	37	50	55	80	100
10	15	20	25	25	32	40	40	45	55	75	100	110
15	22	25	32	40	45	55	55	63	80	100	132	160
—	—	—	—	22	30	50	50	55	80	100	110	150
200	120	120	120	100	100	100	100	100	50	50	50	50

④ 415 V: values in () AC-3 and AC-4 lifespan -25 %
 ⑤ Value applies only to AC-2 and AC-3; AC-4: 360 A

Contactors

Specifications

IEC Specifications

	100-M			100-C, 100S-C						
	05	09	12	09	12	16	23	30	37	
Star-Delta Starting										
≤ 230 V [A]	11	21	21	21	26	35	46	61	66	
≤ 240 V [A]	11	21	21	21	26	35	46	61	66	
400 V [A]	9.2	16	21	16	21	28	40	52	64	
415 V [A]	9.2	16	21	16	21	28	40	52	64	
500 V [A]	6.9	12	12	12	17	24	35	43	52	
690 V [A]	—	—	—	8.6	12	16	21	31	36	
1 000 V [A]	—	—	—	—	—	—	—	—	—	
230 V ❶ [kW]	3	5.5	5.5	5.5	7.5	10	13	17	20	
240 V ❶ [kW]	3	5.5	5.5	5.5	7.5	10	13	18.5	20	
400 V ❶ [kW]	4	7.5	10	7.5	10	13	20	25	32	
415 V ❶ [kW]	4	7.5	11	7.5	11	15	22	25	37	
500 V ❶ [kW]	4	7.5	7.5	7.5	11	15	22	25	32	
690 V ❶ [kW]	—	—	—	7.5	10	13	18.5	25	32	
1 000 V ❶ [kW]	—	—	—	—	—	—	—	—	—	
Short-circuit Protection of Contactors without Motor Protection Relays										
Max. fuse gG per IEC 947-4-1										
Type «1» Coordination max. [A]	25	25	25	50	50	50	80	125	125	
Type «2» Coordination 400 V max. [A]	16	16	16	25	35	35	40	80	80	
Type «2» Coordination 690 V max. [A]	—	—	—	25	35	35	40	80	80	

❶ Power ratings: Preferred values according to IEC 60072-1

100-C, 100S-C				CAB6								
43	60	72	85	-85	-105(-EI)	-140	-140-EI	-170-EI	-210-EI	-250-EI	-300-EI	-420-EI
76	107	125	147	147	182	242	242	294	364	433	520	727
76	107	125	147	147	182	242	242	294	364	433	520	727
74	104	125	147	147	182	242	242	294	364	433	520	727
74	104	125	147	147 (164)❶	182 (225)❶	242 (268)❶	242 (268)❶	294	364 (393)❶	433 (447)❶	520 (546)❶	727 (736)❶
66	95	116	139	147	182	199	242	294	364	433	520	727
43	59	73	85	147	182	199	242	294	364	433	520	727
—	—	—	—	55	65	96	96	112	139	165	200	277
22	32	37	45	45	55	75	75	90	110	132	160	220
22	32	40	50	50	63	80	80	100	125	150	160	250
40	55	63	80	80	100	132	132	160	200	250	300	425
40	55	63	80	80 (90)❶	100 (132)❶	132 (160)❶	132 (160)❶	160	220	250	315 (335)❶	425 (450)❶
45	63	80	90	100	132	132	160	200	250	315	375	530
40	55	63	80	132	160	200	220	300	355	425	530	750
—	—	—	—	75	90	132	132	160	200	220	280	400
160	250	250	250	250	250	315	315	355	500	500	630	630
100	160	160	160	200	200	250	250	315	400	400	500	500
100	160	160	160	200	200	250	250	315	400	400	500	500

❶ 415V: Values in () AC-3 lifespan -25 %

Contactors

Specifications

IEC Specifications

			100-M			100-C, 100S-C					
			05	09	12	09	12	16	23	30	37
Switching of Power Transformers, AC-6a											
Inrush current Rated transformer = n											
n = 30	≤ 230 V	[A]	2.9	5.4	5.4	10.9	10.9	10.9	10.9	20	20
	≤ 240 V	[A]	2.9	5.4	5.4	10.9	10.9	10.9	10.9	20	20
	≤ 400 V	[A]	2.4	4.1	5.4	10.9	10.9	10.9	10.9	20	20
	415 V	[A]	2.4	4.1	5.4	10.9	10.9	10.9	10.9	20	20
	≤ 500 V	[A]	1.8	3.2	3.2	10.9	10.9	10.9	10.9	20	20
	≤ 690 V	[A]	—	—	—	10.9	10.9	10.9	10.9	20	20
	≤ 1000 V	[A]	—	—	—	—	—	—	—	—	—
	230 V	[kVA]	1.2	2.2	2.2	4.3	4.3	4.3	4.3	8	8
	240 V	[kVA]	1.2	2.2	2.2	4.5	4.5	4.5	4.5	8.3	8.3
	400 V	[kVA]	1.7	2.8	3.7	7.5	7.5	7.5	7.5	14	14
	415 V	[kVA]	1.7	2.9	3.9	7.8	7.8	7.8	7.8	14	14
	500 V	[kVA]	1.6	2.7	2.7	9.4	9.4	9.4	9.4	17	17
	690 V	[kVA]	—	—	—	13	13	13	13	24	24
	1000 V	[kVA]	—	—	—	—	—	—	—	—	—
n = 20	≤ 690 V	[A]	—	—	—	16.3	16.3	16.3	16.3	30	30
n = 15	≤ 690 V	[A]	—	—	—	22	22	22	22	40	40
Switching of 3-phase Capacitors, AC-6b											
Inductance of leads between capacitors in parallel: min. 6 μH (100-C09...-C30 contactors: min. 30 μH)											
Single capacitors 40 °C											
	230 V	[kVar]	—	—	—	8	8	8.5	9	14	14
	240 V	[kVar]	—	—	—	8	8	8.5	9	14	14
	400 V	[kVar]	—	—	—	8	8	10	12.5	20	24
	415 V	[kVar]	—	—	—	8	8	10	12.5	20	25
	500 V	[kVar]	—	—	—	8	8	10	12.5	20	25
	690 V	[kVar]	—	—	—	8	8	10	12.5	20	25
	1 000 V	[kVar]	—	—	—	—	—	—	—	—	—
60 °C											
	230 V	[kVar]	—	—	—	8	8	8.5	9	12.5	12.5
	240 V	[kVar]	—	—	—	8	8	8.5	9	12.5	12.5
	400 V	[kVar]	—	—	—	8	8	10	12.5	20	21.5
	415 V	[kVar]	—	—	—	8	8	10	12.5	20	22
	500 V	[kVar]	—	—	—	8	8	10	12.5	20	25
	690 V	[kVar]	—	—	—	8	8	10	12.5	20	25
	1 000 V	[kVar]	—	—	—	—	—	—	—	—	—
Group capacitors 40 °C											
	230 V	[kVar]	—	—	—	5	5	8	9	12.5	14
	240 V	[kVar]	—	—	—	5	5	8	9	12.5	14
	400 V	[kVar]	—	—	—	5	5	8	10	15	20
	415 V	[kVar]	—	—	—	5	5	8	10	15	20
	500 V	[kVar]	—	—	—	5	5	8	10	15	20
	690 V	[kVar]	—	—	—	5	5	8	10	15	20
	1 000 V	[kVar]	—	—	—	—	—	—	—	—	—
60 °C											
	230 V	[kVar]	—	—	—	5	5	8	9	12.5	12.5
	240 V	[kVar]	—	—	—	5	5	8	9	12.5	12.5
	400 V	[kVar]	—	—	—	5	5	8	10	15	20
	415 V	[kVar]	—	—	—	5	5	8	10	15	20
	500 V	[kVar]	—	—	—	5	5	8	10	15	20
	690 V	[kVar]	—	—	—	5	5	8	10	15	20
	1 000 V	[kVar]	—	—	—	—	—	—	—	—	—

100-C, 100S-C				CAB6							
43	60	72	85	-85	-105(-EI)	-140(-EI)	-170-EI	-210-EI	-250-EI	-300-EI	-420-EI
23	40.8	40.8	40.8	53	60	70	85	105	125	150	210
23	40.8	40.8	40.8	53	60	70	85	105	125	150	210
23	40.8	40.8	40.8	53	60	70	85	105	125	150	210
23	40.8	40.8	40.8	53	60	70	85	105	125	150	210
23	40.8	40.8	40.8	53	60	70	85	105	125	150	210
—	—	—	—	53	60	70	85	105	125	150	210
9.2	16	16	16	21	24	28	34	42	50	60	84
10	17	17	17	22	25	29	35	44	52	62	87
16	28	28	28	37	42	48	59	73	87	104	145
17	29	29	29	38	43	50	61	75	90	108	151
20	35	35	35	46	52	61	74	91	108	130	182
27	49	49	49	64	72	84	102	125	149	179	251
—	—	—	—	92	104	121	147	182	217	260	364
34.5	61.3	61.3	61.3	80	90	105	128	158	188	225	315
46	82	82	82	107	120	140	170	210	250	300	420
24	28	28	28	45	45	70	70	98	98	125	139
25	29	29	29	48	48	73	73	102	102	131	145
35	48	48	48	78	78	120	120	170	170	218	242
35	50	50	50	80	80	125	125	176	176	226	252
35	50	55	60	98	98	150	150	212	212	273	303
35	50	55	60	133	133	208	208	293	293	376	418
—	—	—	—	193	193	300	300	424	424	546	606
18	28	28	28	33	33	60	60	84	84	106	119
18	29	29	29	35	35	63	63	87	87	111	124
30	42	48	48	58	58	100	100	145	145	184	206
30	42	50	50	60	60	105	105	151	151	191	214
30	42	50	55	73	73	128	128	182	182	230	258
30	42	50	55	100	100	175	175	251	251	318	356
—	—	—	—	145	145	253	253	364	364	461	515
20	28	28	28	45	40	70	70	98	98	125	139
20	29	29	29	47	45	73	73	102	102	131	145
25	40	48	48	58	75	98	120	170	170	218	242
25	40	50	50	60	78	98	123	170	176	226	252
25	40	50	50	60	78	100	123	172	212	273	303
25	40	50	50	60	78	100	123	174	247	356	418
—	—	—	—	60	80	100	125	177	251	361	606
18	28	28	28	33	35	58	58	84	84	106	119
18	29	29	29	35	38	60	60	87	87	111	124
25	40	48	48	58	58	98	100	145	145	184	206
25	40	50	50	60	60	98	105	151	151	191	214
25	40	50	50	60	73	100	123	172	182	230	258
25	40	50	50	60	78	100	123	174	247	318	356
—	—	—	—	60	80	100	125	177	251	361	515

Contactors

Specifications

IEC Specifications

			100-M			100-C, 100S-C					
			05	09	12	09	12	16	23	30	37
Switching of Lamps											
Gas discharge lamps AC-5a	open	[A]	18	18	18	22.5	25	28	29	40.5	45
	closed	[A]	14.5	14.5	14.5	22.5	25	28	29	37	41
Individually compensated: Max. capacitance at expected Short-circuit current of											
	10 kA	[μF]	750	750	750	1 000	1 000	1 000	1 000	2 700	2 700
	20 kA	[μF]	400	400	400	500	500	500	500	1 350	1 350
	50 kA	[μF]	—	—	—	200	200	200	200	540	540
Filament AC-5b	230/240 V	[A]	9.3	9.3	9.3	12	16	18	22	30	37
Switching of Low Inductive Loads in Home Appliances and Similar Applications											
AC-7a	230 V	[A]	—	—	—	32	32	32	32	45	45
	400 V	[A]	—	—	—	32	32	32	32	45	45
	440 V	[A]	—	—	—	32	32	32	32	45	45
Switching of Motor Load for Home Appliances											
AC-7b	230 V	[A]	—	—	—	10.5	14	19	23	30	—
	400 V	[A]	—	—	—	9	12	16	20	30	—
	440 V	[A]	—	—	—	7.5	10	13.5	18	27	—
Switching of Hermetically Sealed Cooling Compressor Motors											
- manual reset of overload release											
AC-8a	400 V	[A]	—	—	—	12	16	22	32	38	45
	500 V	[A]	—	—	—	12	16	22	32	38	45
	690 V	[A]	—	—	—	8	10	14	20	28	35
- automatic reset of overload release											
AC-8b	400 V	[A]	—	—	—	5.5	7	9.3	12	13	14
	500 V	[A]	—	—	—	5.5	7	9.3	12	13	14
	690 V	[A]	—	—	—	5.5	7	9.3	12	13	14
Switching of DC Loads											
non-inductive or slightly inductive loads or resistance furnaces DC-1 at 60 °C											
1 pole	24 V	[A]	6	9	9	25	25	32	32	45	45
	48/60 V	[A]	4/1	6/1.5	6/1.5	20	20	20	20	25	25
	110 V	[A]	0.6	1	1	6	6	6	6	8	8
	220 V	[A]	0.2	0.3	0.3	1.5	1.5	1.5	1.5	1.5	1.5
	440 V	[A]	0.08	0.1	0.1	0.4	0.4	0.4	0.4	0.4	0.4
2 poles in series	24 V	[A]	6	9	9	25	25	32	32	45	45
	48/60 V	[A]	6	8	8	25	25	32	32	45	45
	110 V	[A]	4	6	6	25	25	32	32	45	45
	220 V	[A]	0.8	1.2	1.2	8	8	8	10	10	10
	440 V	[A]	0.2	0.3	0.3	1	1	1	1	1	1
3 poles in series	24 V	[A]	6	9	9	25	25	32	32	45	45
	48/60 V	[A]	6	9	9	25	25	32	32	45	45
	110 V	[A]	6	9	9	25	25	32	32	45	45
	220 V	[A]	3	4	4	25	25	32	32	45	45
	440 V	[A]	0.4	0.6	0.6	3	3	3	3	3.5	3.5
Shunt-wound Motors											
Starting, reverse current braking, reversing stepping DC-3, 60 °C											
3 poles in series	24 V	[A]	5	9	9	25	25	32	32	45	45
	48/60 V	[A]	4	6	6	25	25	32	32	45	45
	110 V	[A]	2	3	3	20	20	25	25	30	30
	220 V	[A]	0.8	1.2	1.2	6	6	6	10	15	15
	440 V	[A]	0.15	0.2	0.2	0.6	0.6	0.6	0.6	0.6	0.6
Series-wound Motors											
Starting, reverse current braking, reversing stepping DC-5, 60 °C											
3 poles in series	24 V	[A]	5	9	9	25	25	32	32	45	45
	48/60 V	[A]	2	3	3	25	25	32	32	45	45
	110 V	[A]	0.6	1	1	20	20	25	25	30	30
	220 V	[A]	0.1	0.1	0.1	6	6	6	10	15	15
	440 V	[A]	—	—	—	0.6	0.6	0.6	0.6	0.6	0.6
Short Time Withstand I_{CW} , 60 °C											
	10 s	[A]	60	96	96	170	170	170	215	300	304

100-C, 100S-C				CAB6							
43	60	72	85	-85	-105(-EI)	-140(-EI)	-170-EI	-210-EI	-250-EI	-300-EI	-420-EI
77	81	85	90	144	144	225	225	315	315	405	420
57	77	81	90	121.5	121.5	189	189	270	270	342	382.5
3 200	4 000	4 000	4 700	—	—	—	—	—	—	—	—
1 600	2 000	2 000	2 350	—	—	—	—	—	—	—	—
640	800	800	940	—	—	—	—	—	—	—	—
43	60	70	76	107	120	140	170	273	273	300	420
63	—	—	—	—	—	—	—	—	—	—	—
63	—	—	—	—	—	—	—	—	—	—	—
63	—	—	—	—	—	—	—	—	—	—	—
—	—	—	—	—	—	—	—	—	—	—	—
—	—	—	—	—	—	—	—	—	—	—	—
—	—	—	—	—	—	—	—	—	—	—	—
63	72	85	100	—	—	—	—	—	—	—	—
63	72	85	100	—	—	—	—	—	—	—	—
42	56	67	80	—	—	—	—	—	—	—	—
16	24	30	35	—	—	—	—	—	—	—	—
16	24	30	35	—	—	—	—	—	—	—	—
16	24	30	35	—	—	—	—	—	—	—	—
50	70	80	80	120	120	210	210	—	—	—	—
30	40	40	40	120	120	210	210	—	—	—	—
9	11	11	11	120	120	210	210	—	—	—	—
1.5	2	2	2	3	3	4	4	—	—	—	—
0.5	0.5	0.5	0.5	0.6	0.6	1	1	—	—	—	—
50	70	80	80	120	120	210	210	—	—	—	—
50	70	80	80	120	120	210	210	—	—	—	—
50	70	80	80	120	120	210	210	—	—	—	—
10	15	15	15	120	120	210	210	—	—	—	—
1	1.5	1.5	1.5	3	3	4	4	—	—	—	—
63	90	90	100	120	120	210	210	—	—	—	—
63	90	90	100	120	120	210	210	—	—	—	—
63	90	90	100	120	120	210	210	—	—	—	—
50	70	80	80	120	120	210	210	—	—	—	—
4	5	5	5	11	11	11	11	—	—	—	—
63	90	90	100	120	120	210	210	—	—	—	—
50	70	70	80	120	120	210	210	—	—	—	—
35	70	70	80	120	120	210	210	—	—	—	—
20	25	25	30	120	120	210	210	—	—	—	—
0.6	0.6	0.6	0.6	3	3	4	4	—	—	—	—
63	90	90	100	80	80	120	120	—	—	—	—
50	70	70	80	80	80	120	120	—	—	—	—
35	70	70	80	80	80	120	120	—	—	—	—
20	25	25	30	80	80	120	120	—	—	—	—
0.6	0.6	0.6	0.6	1.2	1.2	2	2	—	—	—	—
375	700	700	700	1060	1060	1 390	1 390	2 300	2 570	2 800	4 290

Contactors

Specifications

Specifications

	100-M			100-C, 100S-C					
	05	09	12	09	12	16	23	30	37
Resistance and Power Dissipation									
Main current circuit resistance [mΩ]	5.5	5.5	5.5	2.7	2.7	2.7	2	2	2
Power dissipation by all circuits at I_e AC-3/400 V [W]	0.46	1.3	2.4	0.66	1.2	2.1	3.2	5.4	8.2
Total power dissipation at I_e AC-3/400 V									
AC control [W]	1.9	2.7	3.8	3.3	3.8	4.7	6.2	8.4	11.2
DC control [W]	3.0	3.8	4.9	6.7	7.2	8.1	12.4	14.6	17.4
Load Carrying Capacity per UL/CSA Lloyd's Register of Shipping									
Continuous current (open) [A]	12	12	12	25	25	30	30	45	50
(enclosed) [A]	12	12	12	25	25	30	30	45	50
Rated power									
3-phase motors, 60 Hz, enclosed									
(Direct-on-line) 1-phase 115 V [HP]	0.5	0.5	0.5	0.5	0.5	1	2	2	3
230 V [HP]	1	1.5	2	1.5	2	3	3	5	5
3-phase 200 V [HP]	1.5	2	3	2	3	5	5	7.5	10
230 V [HP]	1.5	2	3	2	3	5	7.5	10	10
460 V [HP]	3	5	7.5	5	7.5	10	15	20	25
575 V [HP]	3	5	10	7.5	10	15	15	25	30
(Reversing combinations) 3-phase 200 V [HP]	1.5	2	3	2	3	5	5	7.5	10
230 V [HP]	1.5	2	3	2	3	5	7.5	10	10
460 V [HP]	3	5	7.5	5	7.5	10	15	20	25
575 V [HP]	3	5	10	7.5	10	15	15	25	30
Lifespan									
Mechanical AC control [Mio. operations]	10	10	10	13	13	13	13	13	13
DC control [Mio. operations]	20	20	20	13	13	13	13	13	13
Electrical AC-3 (400 V) [Mio. operations]	0.7	0.7	0.7	1.3	1.3	1.3	1.3	1.3	1.3
Weight									
AC control [kg]	0.16	0.16	0.16	0.39	0.39	0.39	0.39	0.48	0.49
DC control [kg]	0.16	0.16	0.16	0.6	0.6	0.61	0.73	0.85	0.85







4

100-C, 100S-C				CAB6							
43	60	72	85	-85	-105(-EI)	-140(-EI)	-170-EI	-210-EI	-250-EI	-300-EI	-420-EI
1.5	0.9	0.9	0.9	0.4	0.4	0.42	0.42	0.22	0.22	0.18	0.15
8.3	9.7	14	19.5	8.7	13.2 (13.8)	24.6	36.3	29.4	41.7	48.6	79.5
11.5	11	13.8	17.5	18.2	22.7	34.5	46.5	39.4	51.7	58.6	89.5
18.4	11	13.8	17.5	16.7	20.9	32.5	44.5	37.4	49.7	56.6	87.5
63	90	90	100	178	178	250	250	350	350	420	500
63	90	90	100	160	160	220	220	300	300	340	420
3	5	5	7.5	7.5	10	15	—	—	—	—	—
7.5	10	15	15	15	25	30	40	50	—	—	—
10	15	20	25	25	40	40	50	60	75	100	150
15	20	25	30	30	40	50	60	75	100	125	175
30	40	50	60	60	75	100	150	150	200	250	350
30	50	60	60	75	100	125	150	200	250	300	400
10	15	20	25	25	40	40	50	60	75	100	117
15	20	25	30	30	40	50	60	75	100	125	135
30	40	50	60	60	75	100	150	150	200	250	278
30	50	60	60	75	100	125	150	200	250	300	350
12	10	10	10	10	10	10	10	10	10	10	10
13	10	10	10	10	10	10	10	10	10	10	10
1	1	1	1	1	1	1	1	1	1	1	1
0.51	1.45	1.45	1.45	3.3	3.3 (3.8)	3.3 (3.8)	3.8	7.5	7.5	7.5	7.5
1.0	1.47	1.47	1.47	3.3	3.3 (3.8)	3.3 (3.8)	3.8	7.5	7.5	7.5	7.5

Contactors

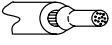
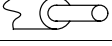
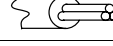
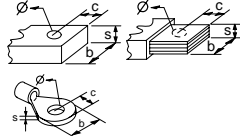
Specifications

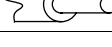

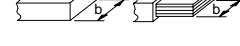

4

			100-M			100-C, 100S-C						
			05	09	12	09	12	16	23	30	37	
Terminal Cross Sections - Main Contacts			 ①			 ①					 ②	
Terminal type												
	1. conductor [mm ²]		0.75 ... 2.5			1 ... 4					2.5 ... 10	
	2. conductors [mm ²]		0.75 ... 2.5			1 ... 4					2.5 ... 10	
	1. conductor [mm ²]		0.75 ... 2.5			1.5 ... 6					2.5 ... 16	
	2. conductors [mm ²]		0.75 ... 2.5			1.5 ... 6					2.5 ... 16	
	b max. [mm]		—			—					—	
	c max. [mm]		—			—					—	
	s max. [mm]		—			—					—	
	o min. [mm]		—			—					—	
Recommended torque		[Nm]	1 ... 1.5			1 ... 2.5					1.5 ... 3.5	
Cross section per UL/CSA		[AWG]	18 ... 14			16 ... 10					14 ... 6	
With terminal lug kit			—			—					—	
Recommended torque		[lb-in]	7 ... 15			8.9 ... 22					13 ... 31	
With Frame Terminal Block												
	1. conductor [mm ²]		—			—					—	
	2. conductors [mm ²]		—			—					—	
	1. conductor [mm ²]		—			—					—	
	2. conductors [mm ²]		—			—					—	
	b max. [mm]		—			—					—	
	s top [mm]		—			—					—	
	s bottom [mm]		—			—					—	
Recommended torque		[Nm]	—			—					—	
Cross section per UL/CSA		top [AWG]	—			—					—	
		bottom [AWG]	—			—					—	
Recommended torque		[lb-in]	—			—					—	

Control Circuits

			100-M			100-C, 100S-C				
			05	09	12	09	12	16	23	30
Operating limits										
50 Hz, 60 Hz, 50/60 Hz	pick-up [x Us]		0.85...1.1			0.85...1.1				
	dropout [x Us]		0.35...0.65			0.3...0.6				
DC control	pick-up [x Us]		0.85...1.1			0.8...1.1				
	dropout [x Us]		0.1...0.25			0.1...0.6				
Pick-up and Holding Power										
50 Hz, 60 Hz, 50/60 Hz	pick-up [VA/W]		22/20			70/50		70/50	80/60	
	holding [VA/W]		4/1.4			8/2.6		9/3	9/3	
DC control	pick-up [W]		2.5			6.5		9.2	9.2	
	holding [W]		2.5			6.5		9.2	9.2	
Switching Delay										
AC	closing delay [ms]		15...40			15...30		15...30	15...30	
	opening delay [ms]		15...25			10...60		10...60	10...60	
With RC module	opening delay [ms]		15...25			10...60		10...60	10...60	
DC	closing delay [ms]		18...40			40...70		40...70	50...80	
	opening delay [ms]		6...12			7...15		7...15	7...15	
Integrated protection circuit	opening delay [ms]		8...12			14...20		17...23	17...23	
With diode	opening delay [ms]		35...50			70...95		80...125	80...125	

- ① Pozidriv No. 2 / Blade No. 3 screw
- ② Pozidriv No. 2 / Blade No. 4 screw
- ③ Hexagonal socket screw
- ④ Hexagonal screw

100-C, 100S-C				CAB6								
43	60	72	85	-85	-105	-105-EI	-140(-EI)	-170-EI	-210-EI	-250-EI	-300-EI	-420-EI
												
2.5 ... 16 2.5 ... 10		2.5 ... 35 2.5 ... 25		—			—				—	
2.5 ... 25 2.5 ... 15		2.5 ... 50 2.5 ... 35		—			—				—	
		—		20			25				30	
		—		10			12.5				15	
		—		2 x 5			2 x 5				2 x 6	
		—		6.1			8.3				10.5	
1.5 ... 3.5		2 ... 6		8...10			10...12				16	
14 ... 6		14 ... 2		6...2/0			6...250 MCM				8...600 MCM	
		—		CAB6-105-HU ⑤			CAB6-170-HU ⑤				825-ML630 / CA 6-420-HU ⑤	
13 ... 31		18 ... 52		70...90			90...110				130...150	
		—		CAB6-HB1 ⑤			CAB6-HB2 ⑤				⑥ CAB6-HB3 ⑤	
		—		16 ... 35 16 ... 70			⑤ 16 ... 35 ⑤ 16 ... 95				25 ... 240 ⑦ 25 ... 240	
		—		16 ... 50 16 ... 95			⑤ 16 ... 50 ⑤ 16 ... 120				25 ... 300 25 ... 300	
		—		16 3 ... 9 3 ... 12			20 3 ... 9 3 ... 14				25 4 ... 20 4 ... 20	
		—		8 ... 10			10 ... 12				20 ... 25	
		—		No. 6 ... 1 / 0 AWG			No. 6 ... 1 / 0 AWG				No. 4 AWG ... 600 MCM	
		—		No. 6 ... 3 / 0 AWG			No. 6 AWG ... 250 MCM				No. 4 AWG ... 600 MCM	
		—		70 ... 90			90 ... 110				180 ... 220	

100-C, 100S-C				CAB6								
43	60	72	85	-85	-105/-140	-105-EI	-140-EI	-170-EI	-210-EI	-250-EI	-300-EI	-420-EI
	0.85 ...1.1			0.85 ...1.1					0.85 ...1.1			
	0.3 ...0.6			0.3 ...0.6					0.3 ...0.5			
	0.8 ...1.1			0.85 ...1.1					0.85 ...1.1			
	0.1 ...0.6			0.3 ...0.6					0.3 ...0.5			
130/90		200/110		650/310				370/243 ⑤				590/355 ⑤
10/3.2		16/4.5		50/10				12/6				15/7
10.1		200		540				190 ⑤				375 ⑤
10.1		4.5		8				6				7
15...30		20...40		20...47				75...90				75...90
10...60		10...60		6...12				30...60				30...60
10...60		10...60		9...18				—				—
50...80		20...40		27...47				75...90				75...90
7...15		—		12...20				30...60				30...60
17...23		≤ 220 V 20...35		12...20				—				—
80...125		> 220 V 80...125		—				—				—

⑤ With CT(A)B6-150 / 200 min. 25 mm²

⑥ CAB6-HB3 not for use with CEFB1-41 / 42 and 825-MCM630 in preparation



⑦ 25 ... 95 mm² with sleeve per DIN 46228

⑧ Electronic coil drives are controlled for minimizing performance, but this control may shortly require (< 1 ms) peak load when attracting. This must be taken into account for the dimensioning of supply devices, all-or-nothing relays and cross-sections of coil supply lines. Please contact your nearest Rockwell Automation sales office for detailed information

Contactors

Specifications

Auxiliary Contacts and Auxiliary Contact Blocks

			Auxiliary contact for 100-M		Auxiliary contact for 100-C, 100S-C			Auxiliary contact for CAB6	
			Internal	Blocks	Internal	Front-mounted	Side-mounted	Conventional	Electronically compatible
Switching of AC Loads									
AC-12	<i>I</i> _{th}	at 40 °C [A]	16	10	25	10	10	16	0.1 at 250 V
		at 60 °C [A]	12	6	20	6	6	12	
AC-15 at rated voltage of									(1 ... 100 mA) at 3 ... 125 V
	24 V	[A]	—	—	10	6	3	—	
	42 / 48 V	[A]	—	—	10	6	3	—	
	110 V	[A]	—	—	10	6	3	—	
	230 V	[A]	6	2	10	5.5	3	5.5	
	240 V	[A]	5	2	10	5	3	5	
	400 V	[A]	2.5	1	6	3	2	3	
	415 V	[A]	2	1	5	2.5	2	2.5	
	500 V	[A]	1.25	0.6	2.5	1.6	1.6	1.6	
	690 V	[A]	—	—	1	1	0.75	1	
Switching of DC Loads									
DC-12 L/R < 1 ms resistive loads at									
	24 VDC	[A]	6	6	12	12	6	16	—
	48 VDC	[A]	4	2	9	9	3.2	9	—
	110 VDC	[A]	0.6	0.6	3.5	3.5	0.45	3.5	—
	220 VDC	[A]	0.2	0.2	0.55	0.55	0.18	0.55	—
	440 VDC	[A]	0.08	0.08	0.2	0.2	0.1	0.2	—
DC-14 L/R < 15 ms inductive loads with economy resistor in series at									
	24 VDC	[A]	4	4	9	9	2	9	—
	48 VDC	[A]	2.5	1.2	5	5	1.6	5	—
	110 VDC	[A]	0.4	0.4	2	2	.3	2	—
	220 VDC	[A]	0.12	0.12	0.4	0.4	0.12	0.4	—
	440 VDC	[A]	0.05	0.05	0.16	0.16	0.05	0.16	—
DC-13 switching electromagnets at									
	24 VDC	[A]	5	2	5	5	3	5	(1 ... 100 mA) at 3 ... 125 V
	48 VDC	[A]	0.6	0.6	2	2	1.5	2	
	110 VDC	[A]	0.45	0.45	0.7	0.7	0.6	0.7	
	220 VDC	[A]	0.25	0.1	0.25	0.25	0.3	0.25	
	440 VDC	[A]	0.04	0.04	0.12	0.12	0.2	0.12	
Fuse gG									
Short-circuit protection with no									
Welding of contacts per IEC 947-5									
		[A]	16	10	10	10	10	16	—
		[A]	16	10	10	10	10	16	—
Safe isolation					between load and auxiliary circuit 250 V	between load and auxiliary circuit 500 V			
Min. Short-circuit switching capacity 17 V DIN 19240 Auxiliary contacts [mA]			5	5	5	5	5	5	1 
Load Carrying Capacity per UL/CSA									
Rated voltage	AC	[V]	max. 600			max. 600		max. 600	max. 250
Continuous rating	40 °C	[A]	10 General purpose		10	10	10	10 General purpose	0.1
Switching capacity	AC	[A]	Heavy pilot duty (A 600)			A 600		Heavy pilot duty (A 600)	0.1
Rated voltage	DC	[V]	max. 600			max. 600		max. 600	max. 250
Switching capacity		[A]	Light pilot duty (Q 600)		P 600	Q 600		Standard pilot duty (P 600)	0.1

 Only with CAB6-P2-B11 and CAB6-P3-B11

General

	100-M		100-C, 100S-C	CAB6
	05 ... 09	12	09 ... 85	-85 ... 420-EI
Rated Isolation Voltage U_i				
IEC, AS, BS, SEV, VDE 0660 [V]	500		690	1000
per UL, NEMA, CSA, EEMAC [V]	600		600	600
Rated Impulse Voltage Withstand U_{imp} [kV]	8		8	12
Rated Voltage U_e				
AC 50/60 Hz [V]	230, 240, 400, 415, 500		115, 230, 400, 500, 690	230, 240, 400, 415, 500, 690, 1000
DC [V]	24, 48, 110, 220, 440		24, 48, 110, 220, 440	24, 48, 110, 220, 440
Insulation Class of the Coil	Class «B» per IEC 85		Class «F» per IEC 85	Class «B» per VDE 0660, Table 22
Rated coil frequency	AC 50/60 Hz, DC		AC 50/60 Hz, DC	AC 50 Hz, 50/60 Hz, DC
Ambient Temperature				
Storage [°C]	-55 ... +80		-55 ... +80	-40 ... +80
Operation at rated voltage at 70 °C [°C]	-25 ... +60		-25 ... +60	-25 ... +60
	15 % current reduction against 60 °C values			
Climatic Withstand	IEC 68-2		IEC 68-2	IEC 68-2
Max. Altitude of Installation Site [m]	2000 NN, per IEC 947-4		2000 NN, per IEC 947-4	2000 NN, per IEC 947-4
Protection Class	IP2X		IP2X (in connected state)	IP00 IEC 529 / DIN 40 050
Single contactor cover	—			IP10 IEC 529 / DIN 40 050
Contact with frame terminal block	—			IP20 IEC 529 / DIN 40 050
Auxiliary contact	—			IP20 IEC 529 / DIN 40 050
Protection against Accidental Contact	Finger and back-of-hand proof per VDE 0106, part 100		Finger and back-of-hand proof per VDE 0106, part 100	Finger and back-of-hand proof per VDE 0106, part 100
Resistance to Shock	IEC 68-2		IEC 68-2	IEC 68-2
Resistance to Vibration	IEC 68-2		IEC 68-2	IEC 68-2
Positively Guided Contacts per SUVA	Contactor contacts among each other. Auxiliary contact block contacts next to each other. But not between contactor and auxiliary contact block.		Restricted guidance guarantees without restrictions from contactor to auxiliary contact and auxiliary contact to contactor. No restricted guidance 100-FL, 100-FPT	—
Standards	IEC 60947; EN 60947; UL 508; CSA 22.2. No. 14		IEC 60947; EN 60947; UL 508; CSA 22.2. No. 14	IEC 60947; EN 60947; UL 508; CSA 22.2. No. 14
Approvals	CE, UL Listed, CSA, Germanischer Lloyd, Bureau Veritas, Lloyd's Register of Shipping, Maritime Register of Shipping	CE, UL Listed, CSA,	CE, UL Listed, CSA, RINA, Bureau Veritas, Maritime Register of Shipping, American Bureau of Shipping, Germanischer Lloyd, Lloyd's Register of Shipping, Wershe Veritas in preparation	CE, UL Listed, CSA

Contactors

Specifications

Heavy Duty Starting and Regular Short-time Operation

Bulletin 100-C, CAB6 Contactors

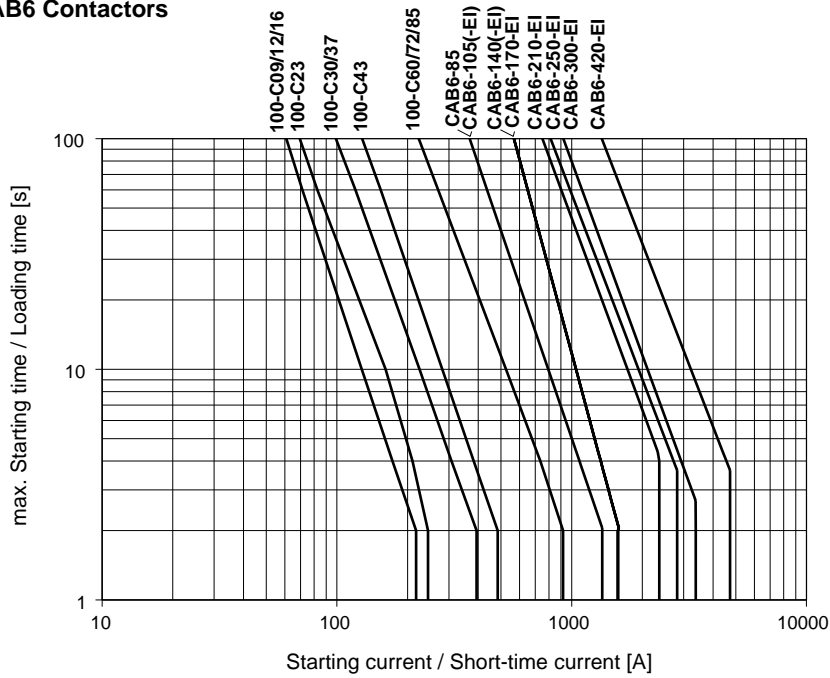

Electrical Life

Bulletin 100-M, 100-C, 100S-C, CAB6 Contactors

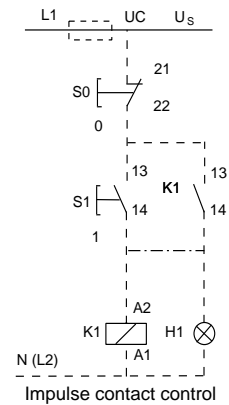
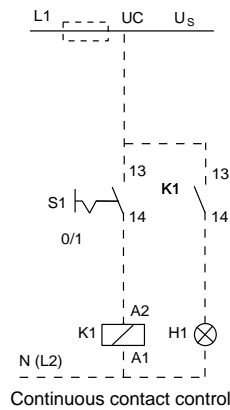
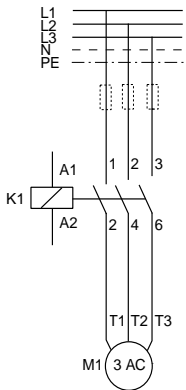

Utilisation categories

Switching conditions for verifying electrical life (number of operations under load) per IEC 947-4; -5.

Test conditions		Making			Breaking			
		I/I_e	U/U_e	$\cos\phi$	I_c/I_e	U_r/U_e	$\cos\phi$	
AC-1	Resistance furnaces: Non-inductive or slightly inductive loads	1	1	0.95	1	1	0.95	
AC-2	Slip-ring motors: Starting and reversing	2.5	1	0.65	2.5	1	0.65	
AC-3	Squirrel-cage motors: Starting and stopping of running motors	$I_e \leq 17 A$	6	1	0.65	1	0.17	0.65
		$I_e > 17 A$	6	1	0.35	1	0.17	0.35
AC-4	Squirrel-cage motors: Starting, reversing, stepping	$I_e \leq 17 A$	6	1	0.65	6	1	0.65
		$I_e > 17 A$	6	1	0.35	6	1	0.35
AC-15	Solenoids: for contactors, valves, and lifting magnets	10	1	0.7	1	1	0.4	

I_e Rated operating current
 U_e Rated operating voltage

U_r Recovery voltage
 I Making current

I_c Breaking current
 U Off-load voltage

The following values are valid for the operating conditions defined in IEC 947-4 and utilisation categories AC-1...AC-4 at 400V, 50/60 Hz.

Electrical Life

100-M

Electrical Life; $U_e = 400 / 415$ VAC

AC-3 Switching of squirrel-cage motors while starting

AC-1 Non- or slightly inductive loads, resistance furnaces

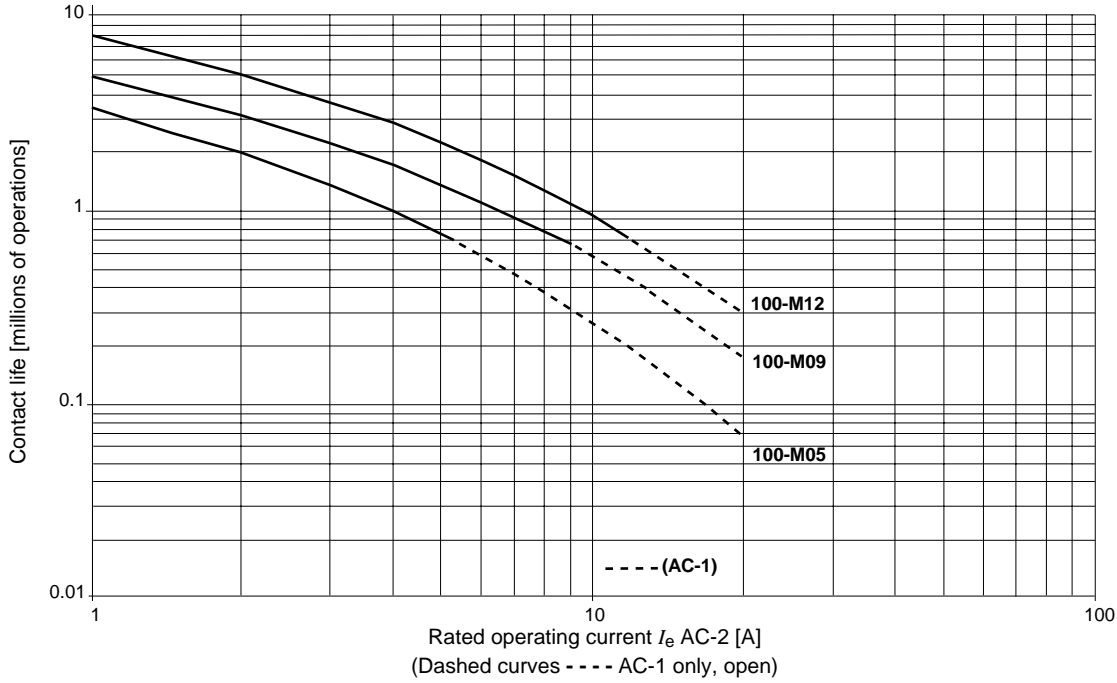

100-M

Electrical Life; $U_e = 400 / 415$ VAC

AC-4 Stepping of squirrel-cage motors

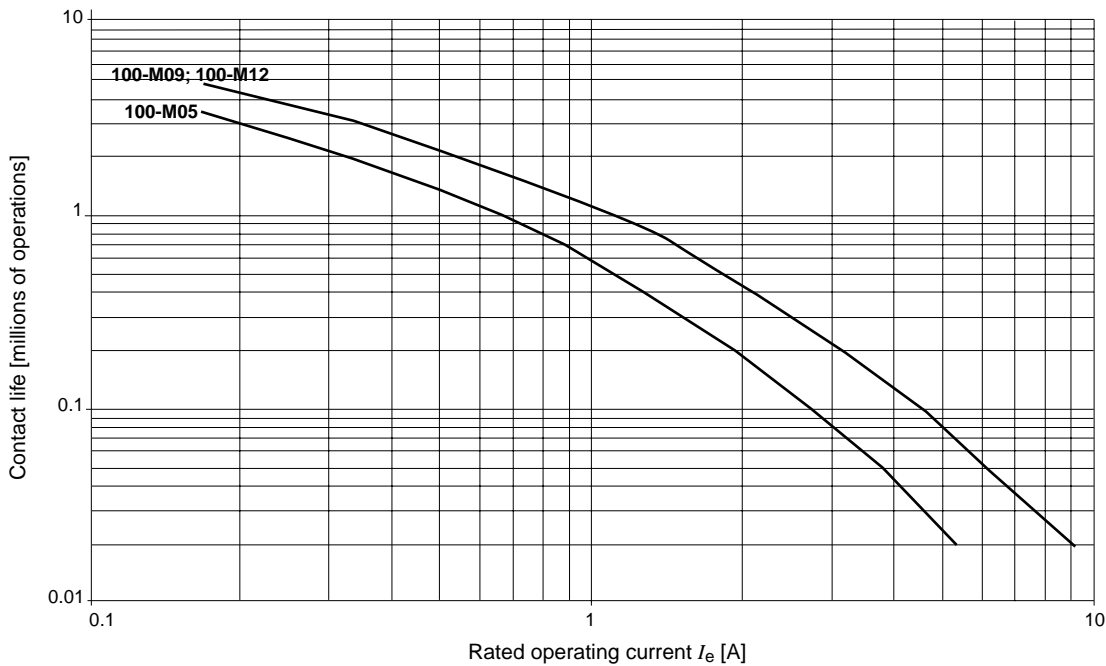

Contactors

Specifications

Electrical Life

100-C

AC-1 40° C Non- or slightly inductive loads, resistance furnaces; $U_e = 230...690 V$

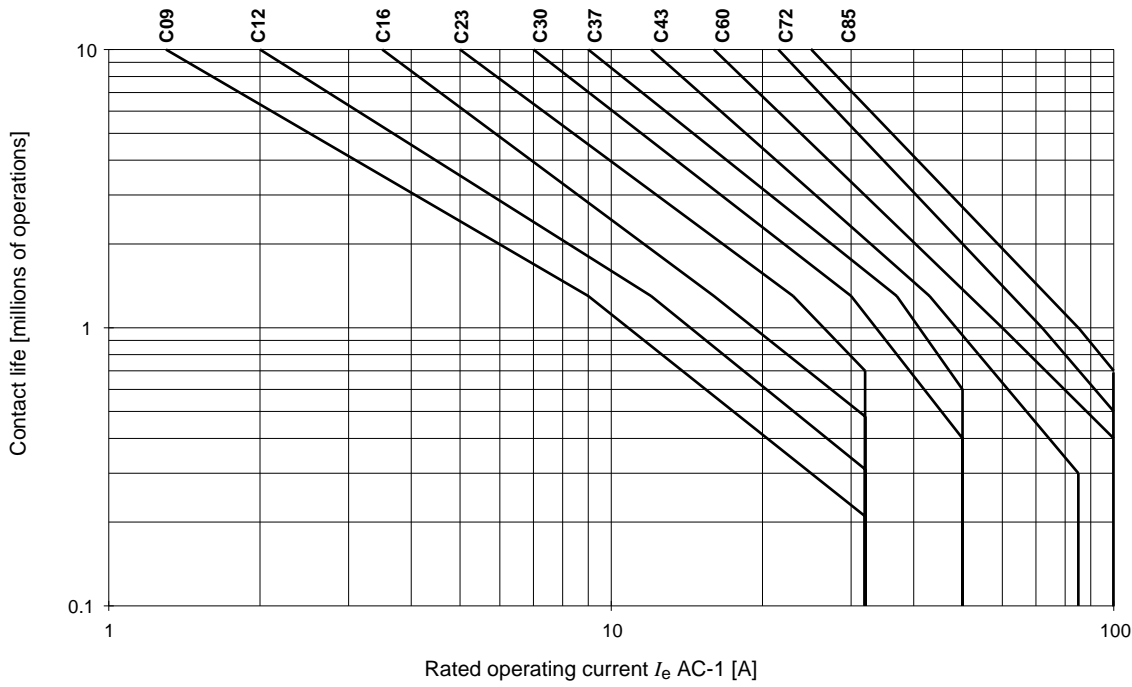

100-C

AC-2 Stepping of slip-ring motors; $U_e = 230...400...460 V$

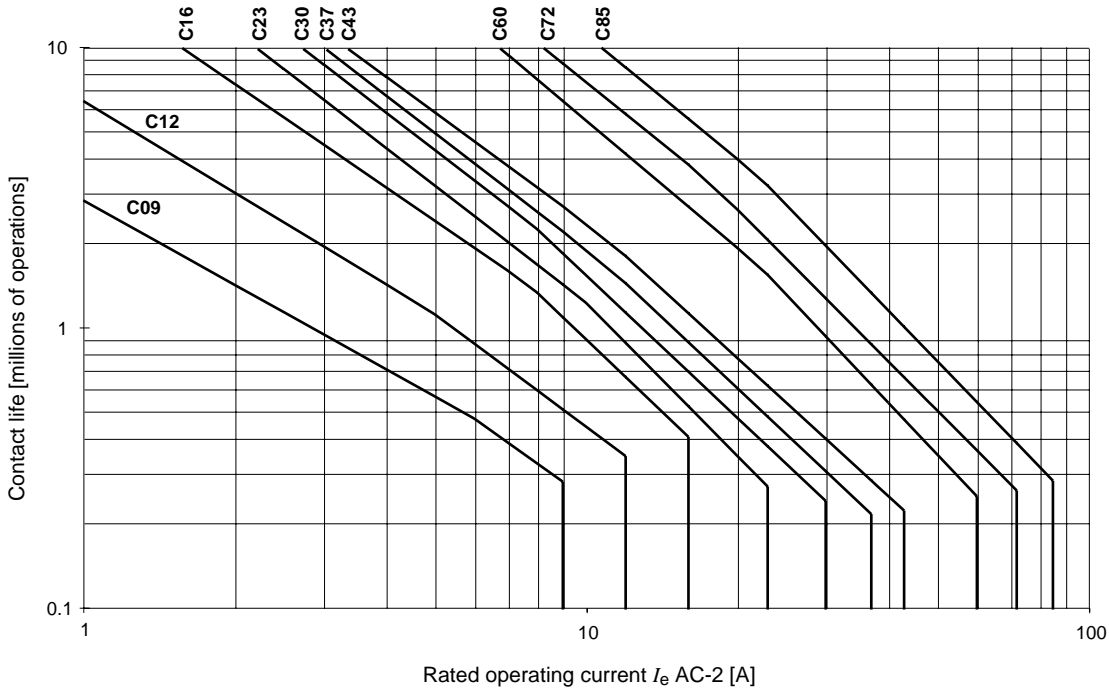

Electrical Life

100-C

AC-3 Switching of squirrel-cage motors while starting; $U_e = 230...400...460\text{ V}$

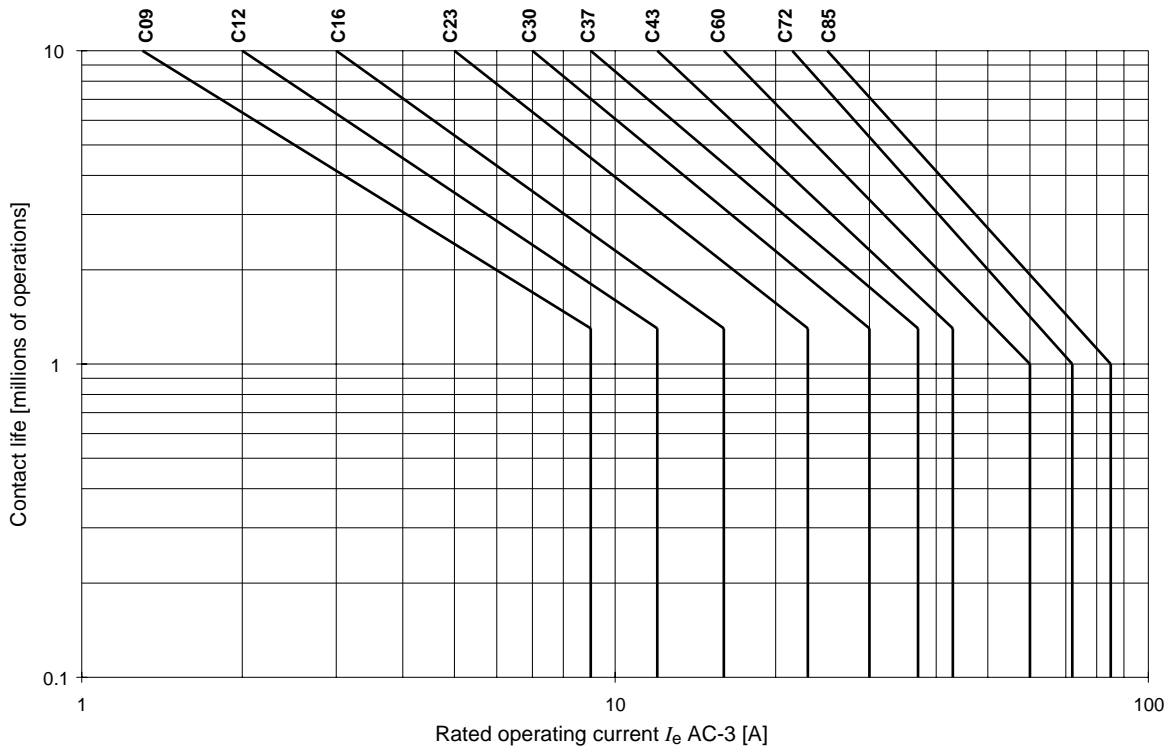

100-C

AC-3 Switching of squirrel-cage motors while starting; $U_e = 500...575\text{ V}$

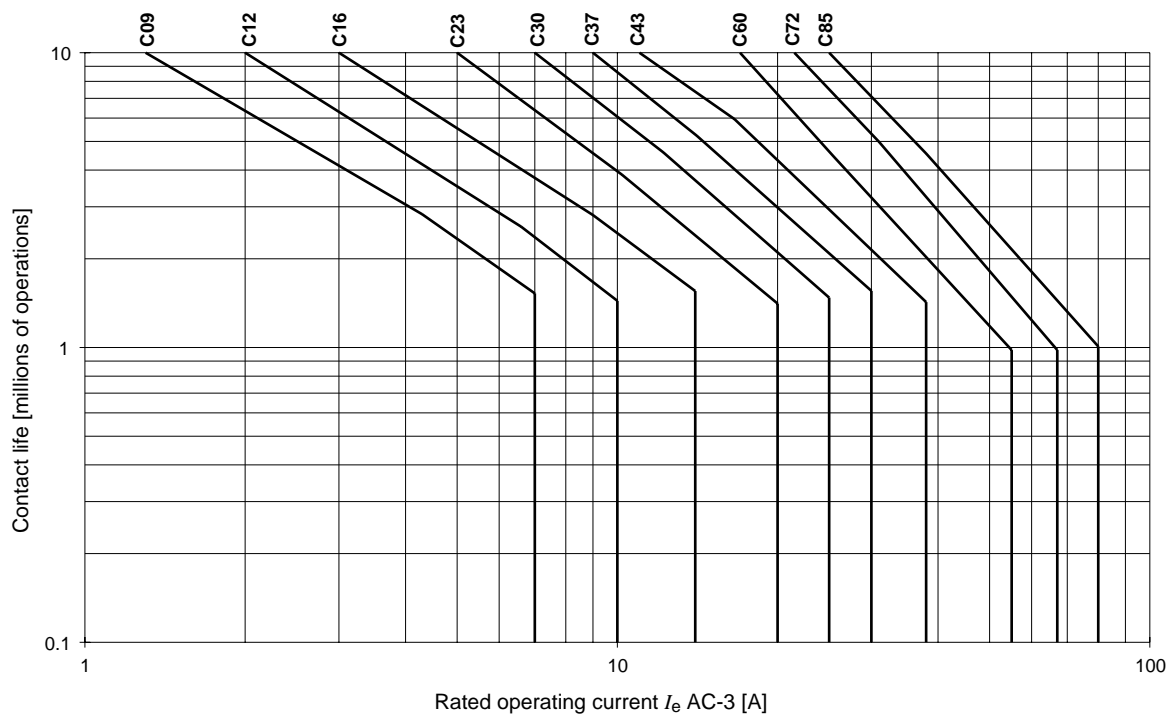

Contactors

Specifications

Electrical Life

100-C

AC-3 Switching of squirrel-cage motors while starting; $U_e = 690\text{ V}$

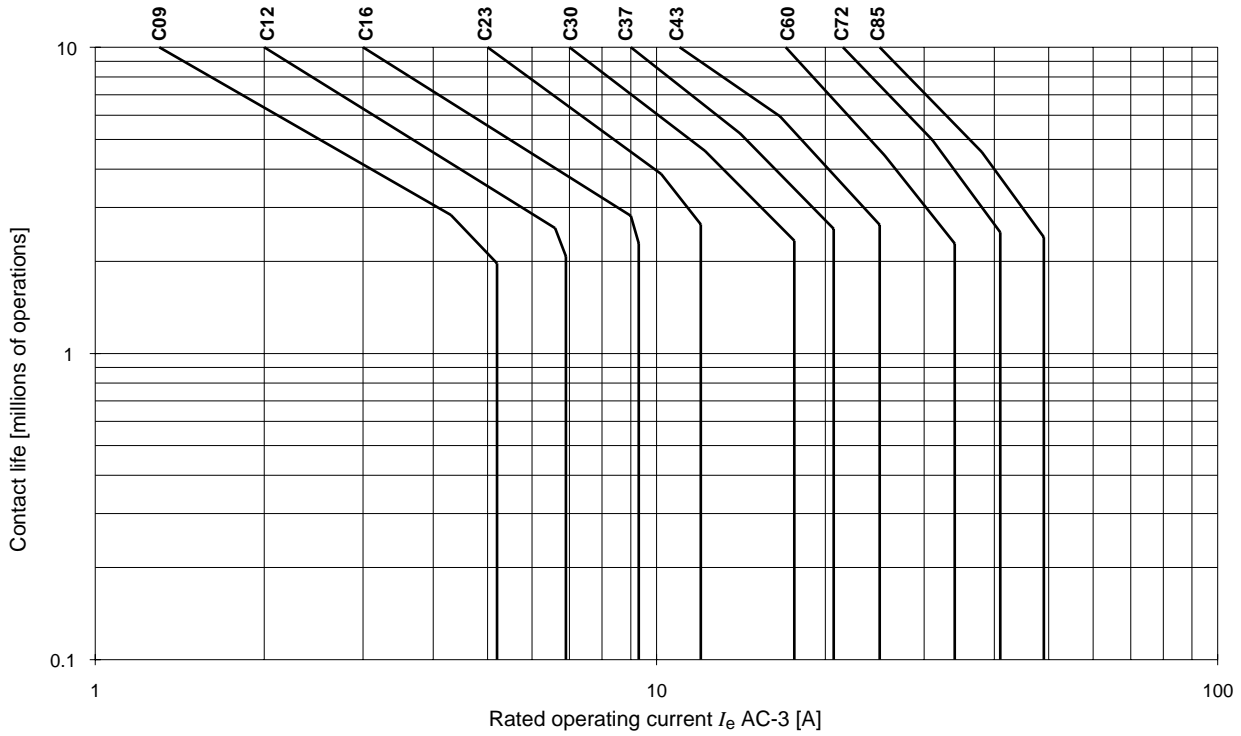

100-C

AC-4 Stepping of squirrel-cage motors; $U_e = 230\text{...}690\text{ V}$

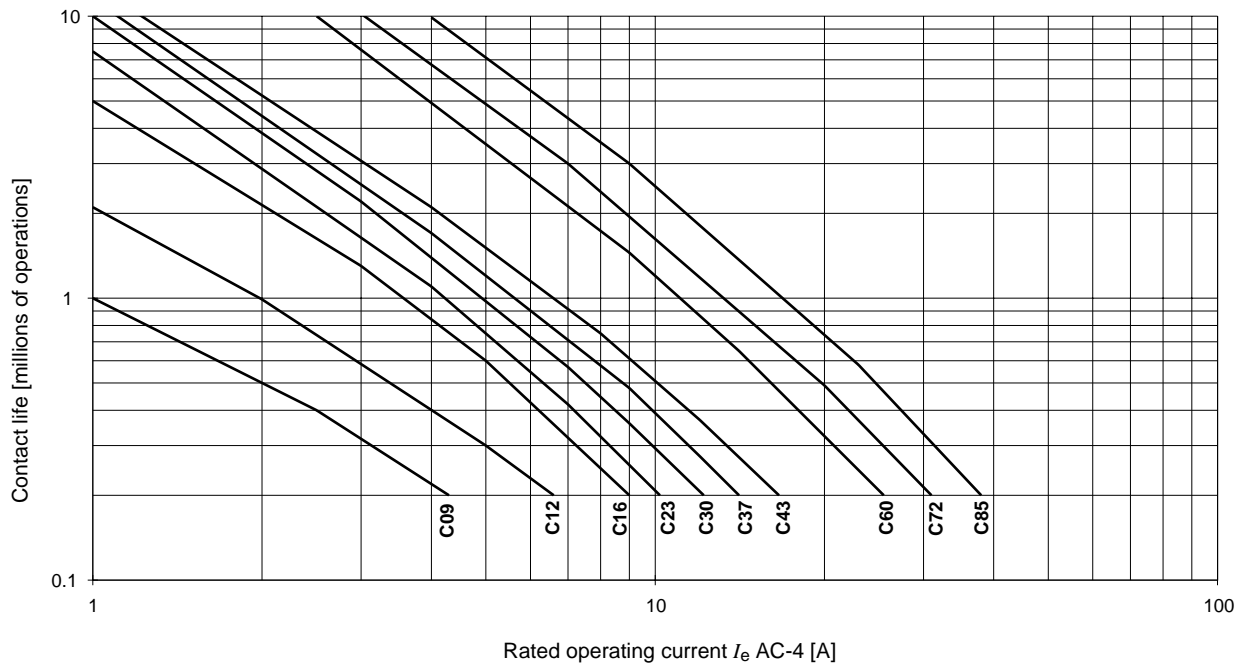

Electrical Life

100-C

AC-3 90 % & AC-4 10 % Mixed operation of squirrel-cage motors; $U_e = 230...400...460\text{ V}$

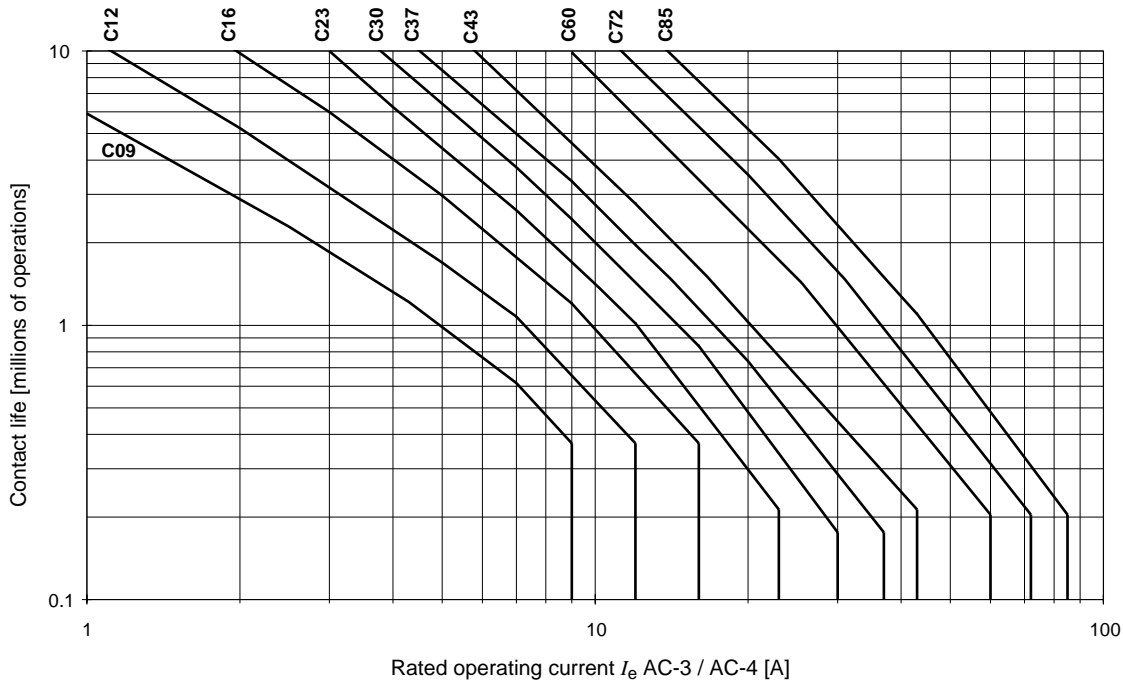

CAB6

AC-3 Switching of squirrel-cage motors while starting

AC-1 Non- or slightly inductive loads, resistance furnaces; $U_e = 400\text{ V}$

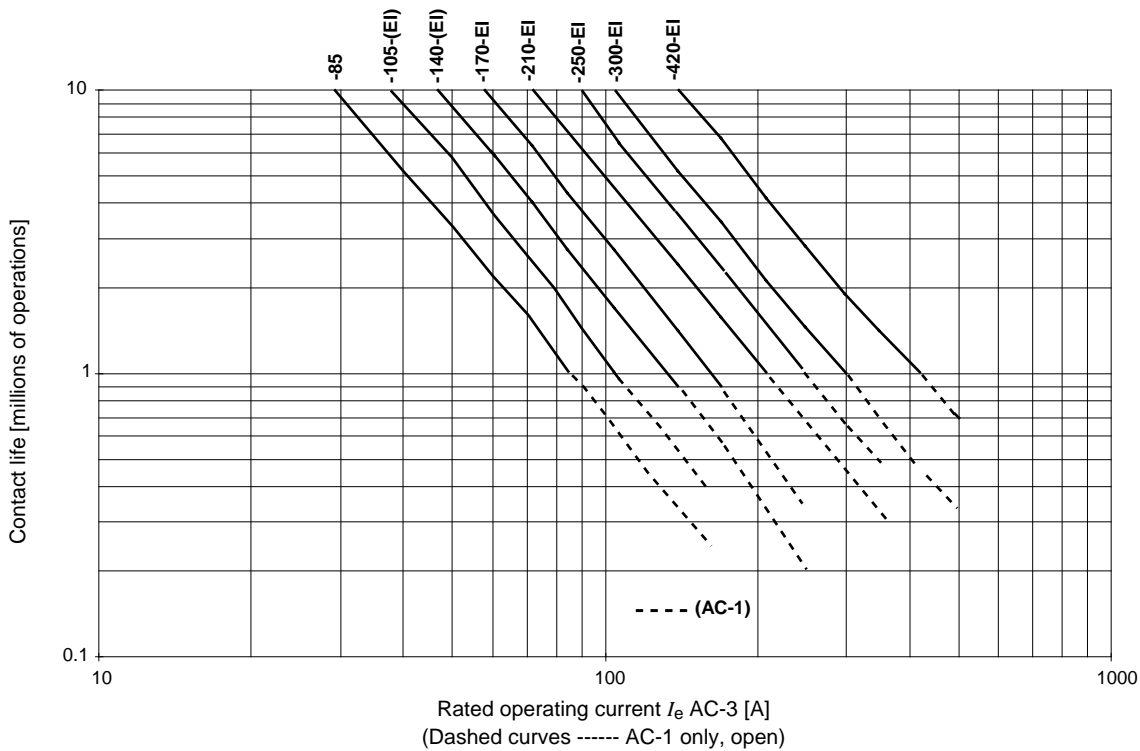

Contactors

Specifications

Electrical Life

CAB6

AC-4 Stepping of squirrel-cage motors; $U_e = 400\text{ V}$

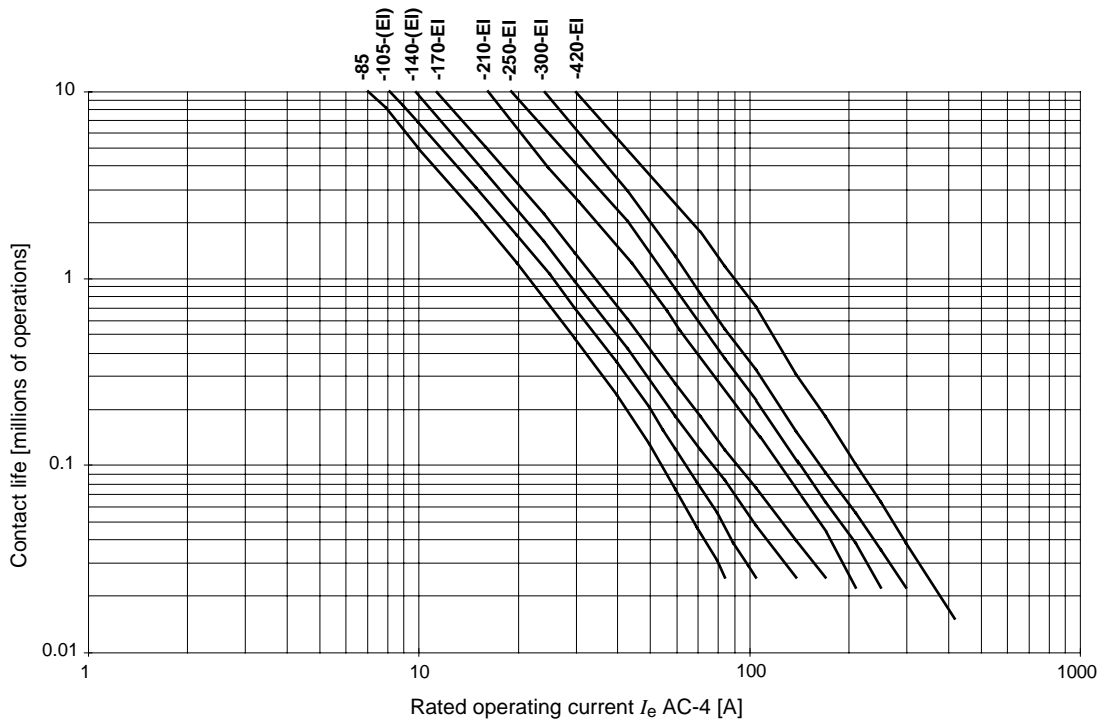

CAB6

AC-3 90 % & AC-4 10 % Mixed operation of squirrel-cage motors; $U_e = 400\text{ V}$

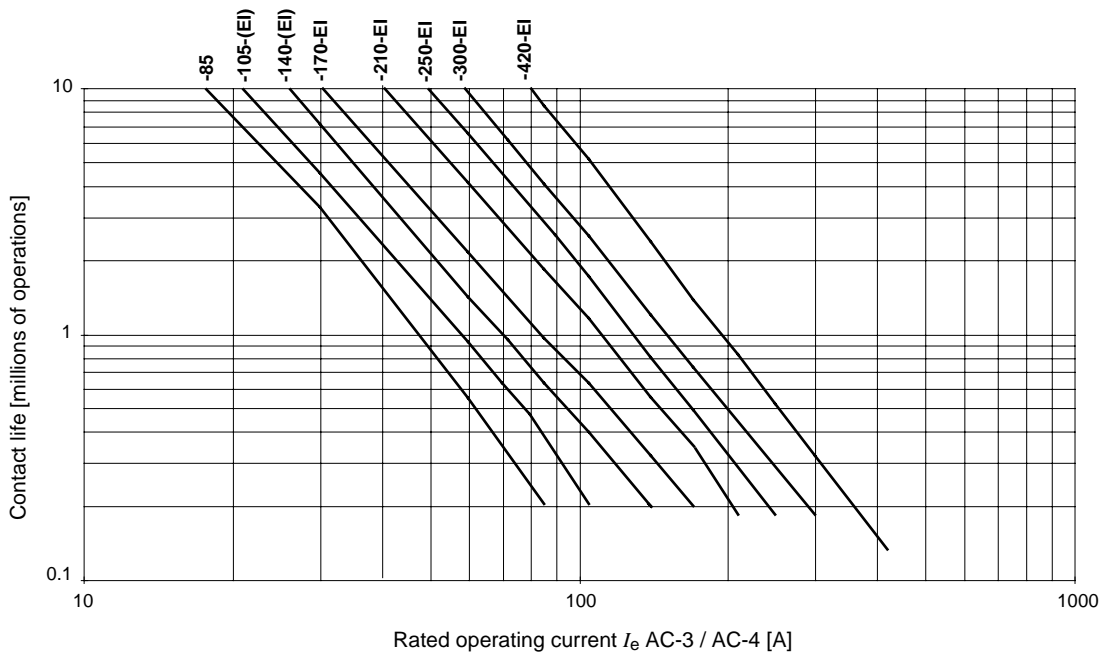

Permissible Switching Rate

100-C

AC-1 40° C Non- or slightly inductive loads, resistance furnaces; $U_e = 230...690$ V

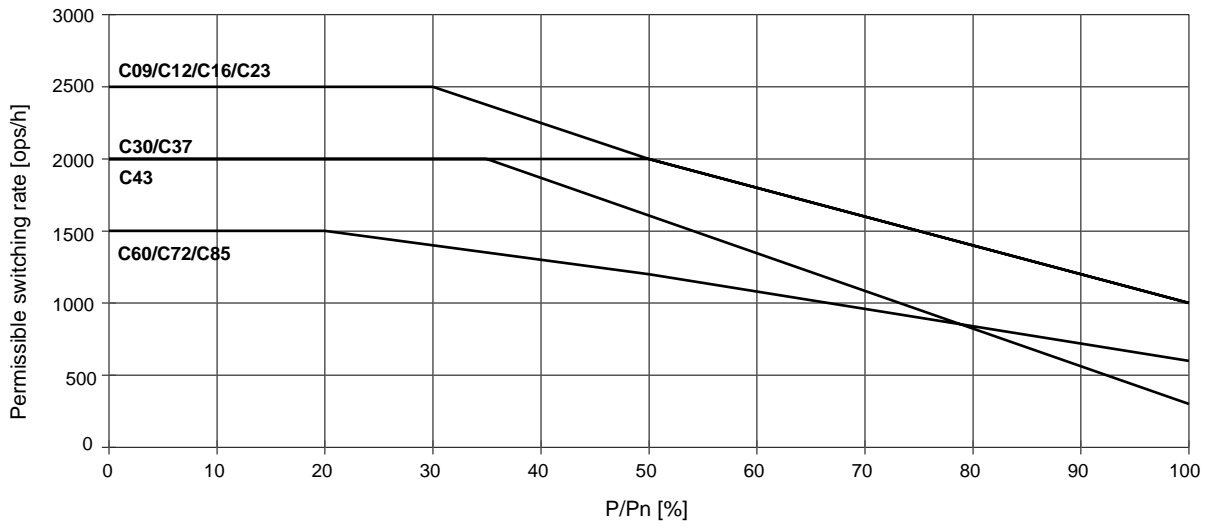

100-C

AC-2 Stepping of slip-ring motors; $U_e = 230...460$ V

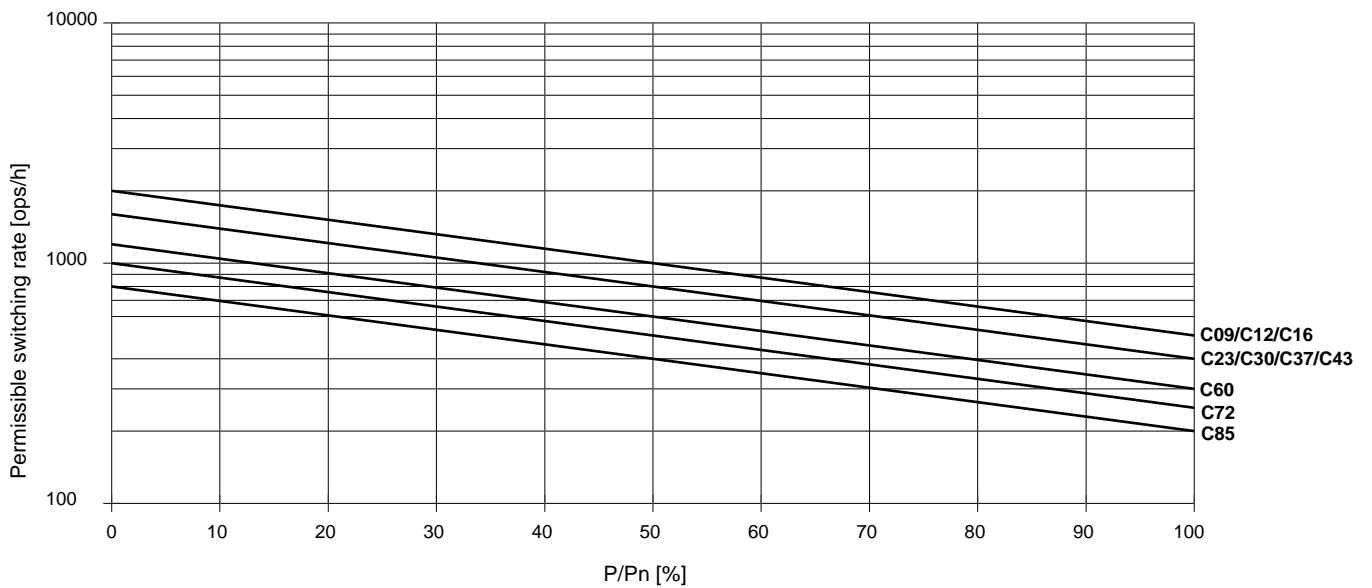

Permissible Switching Rate

100-C

AC-3 Switching of squirrel-cage motors while starting; $U_e = 230...460\text{ V}$
 Relative operating time 40 %, Starting time $t_A = 0.25\text{ s}$

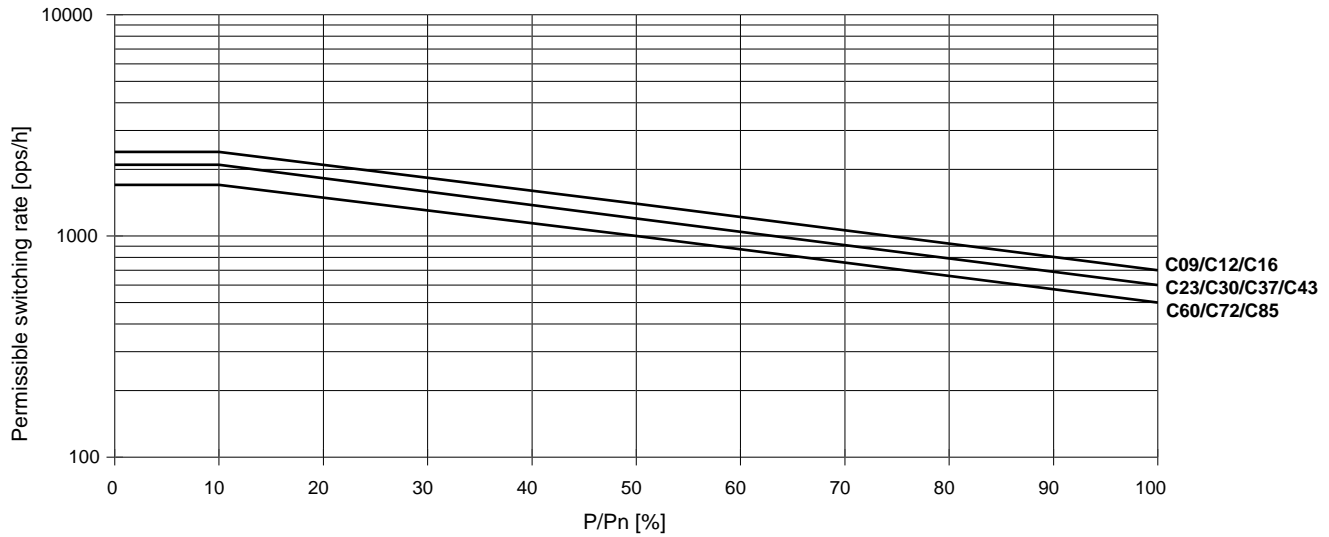

100-C

AC-4 Stepping of squirrel-cage motors; $U_e = 230...460\text{ V}$
 Starting time $t_A = 0.25\text{ s}$

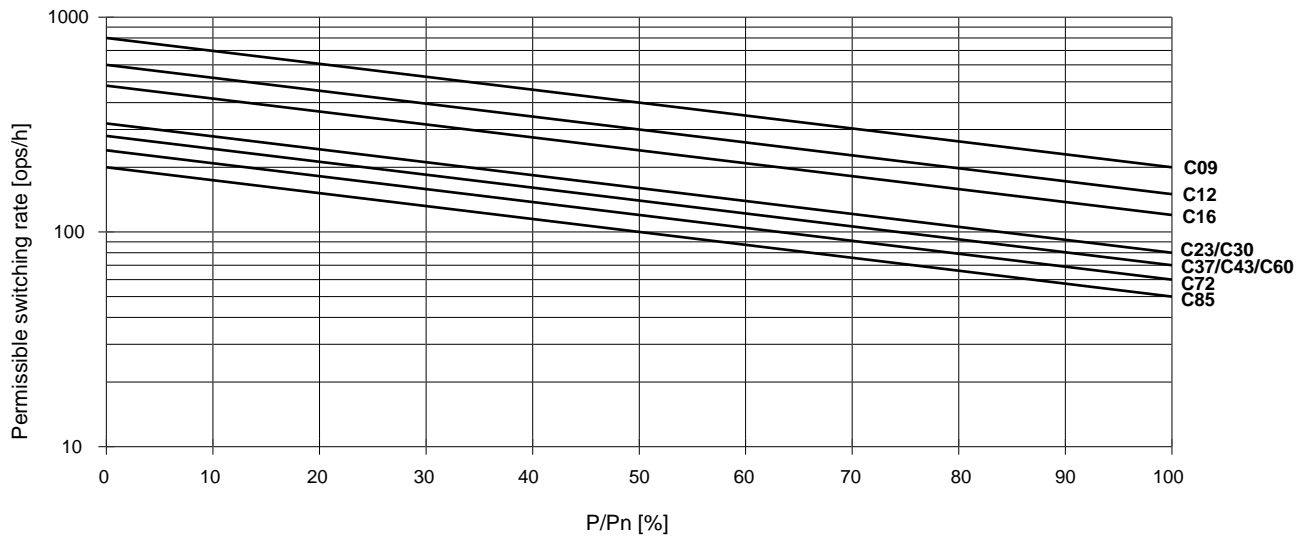

Permissible Switching Rate

CAB6

AC-3 Switching of squirrel-cage motors while starting
Relative operating time 40 %, Starting time $t_A = 0.25$ s

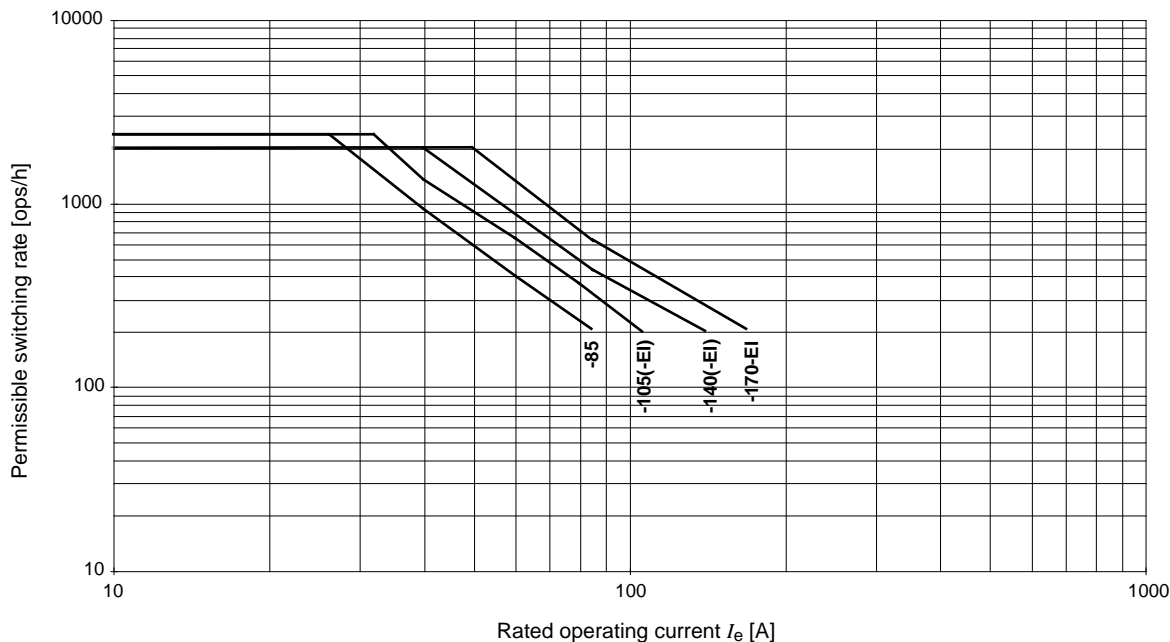

CAB6

AC-3 Switching of squirrel-cage motors while starting
Relative operating time 40 %, Starting time $t_A = 1$ s

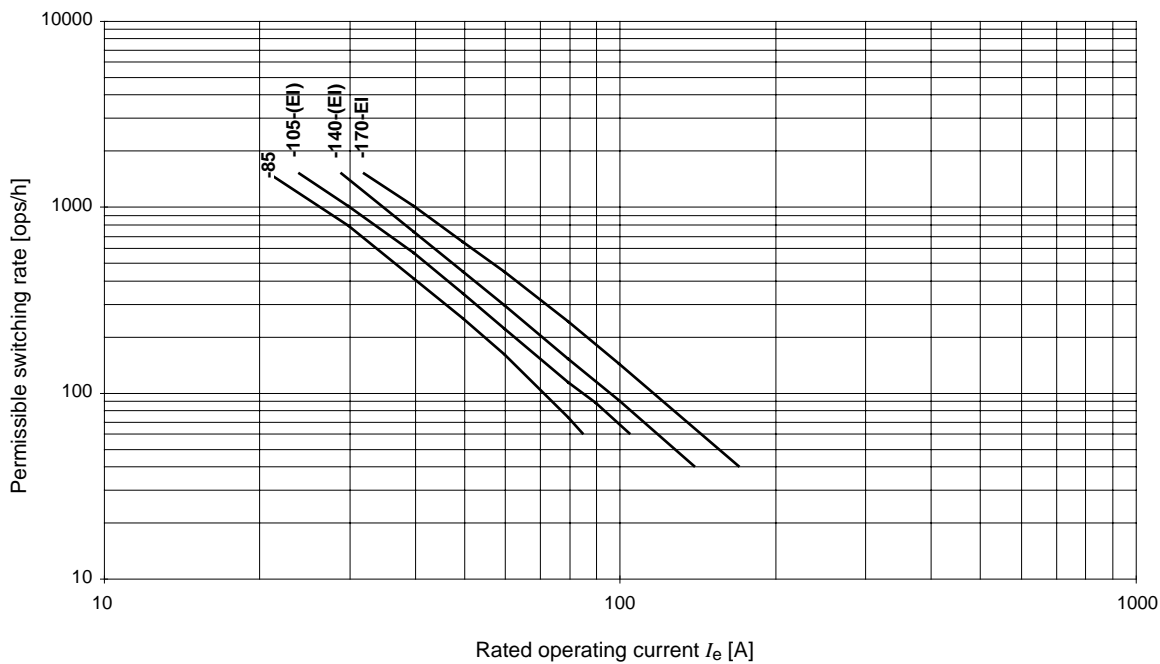

Contactors

Specifications

Permissible Switching Rate

CAB6

AC-2, AC-4 Stepping of motors

Starting time $t_A = 0.25$ s

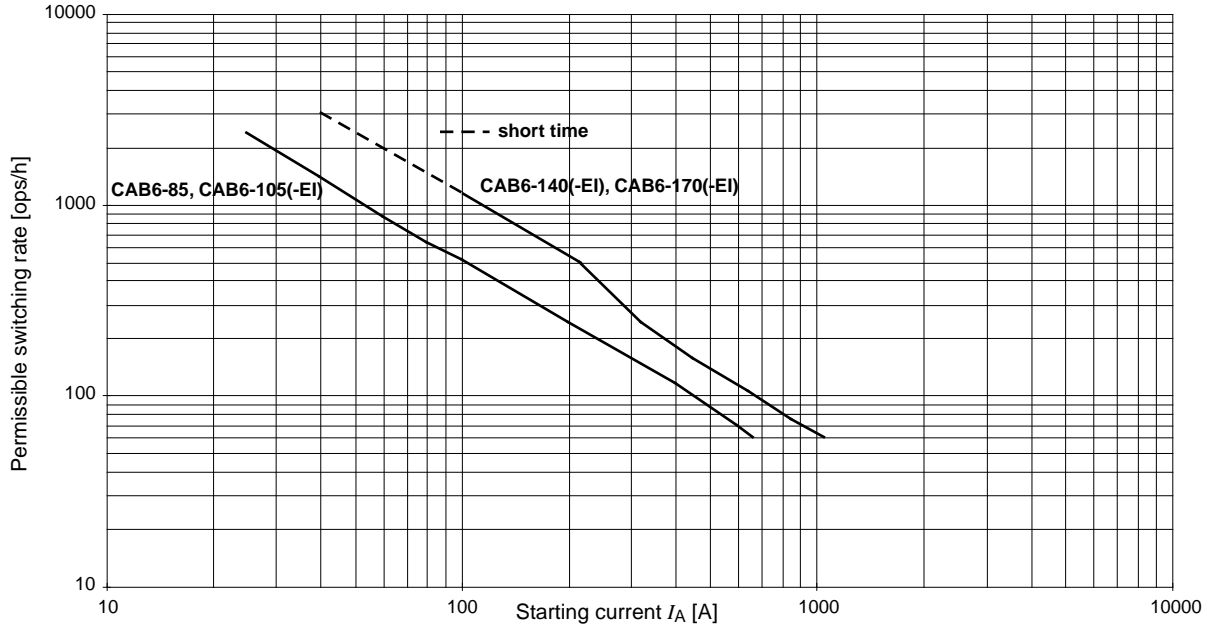

CAB6

AC-2, AC-4 Stepping of motors

Starting time $t_A = 1$ s

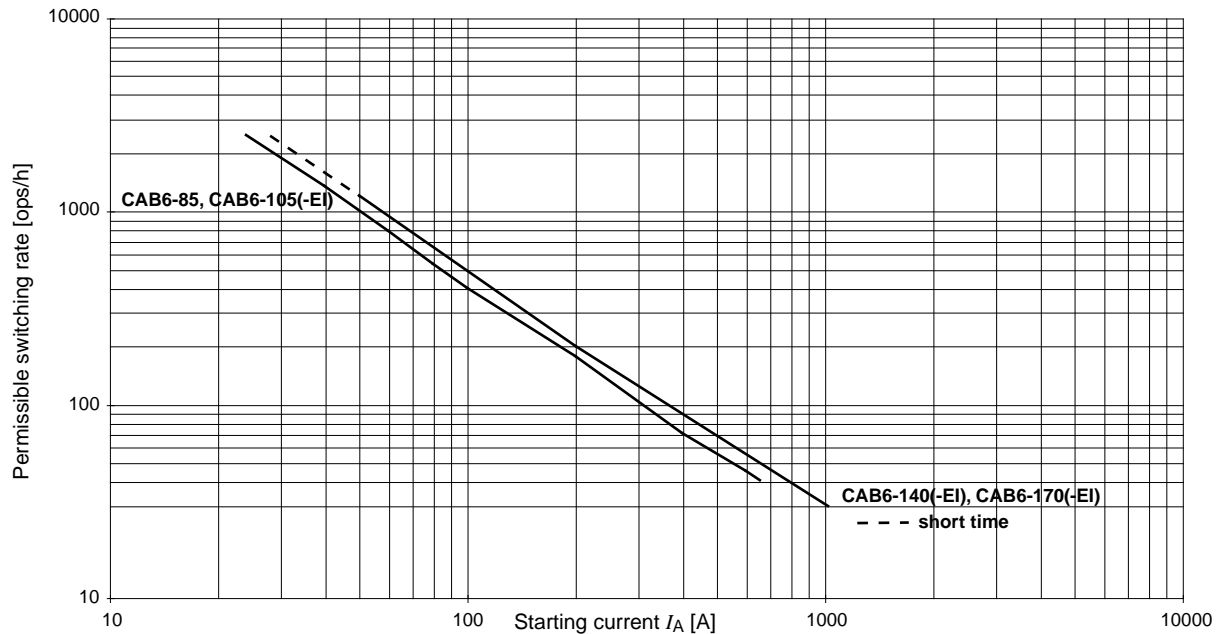

Bulletin 100-M

Dimensions in millimetres

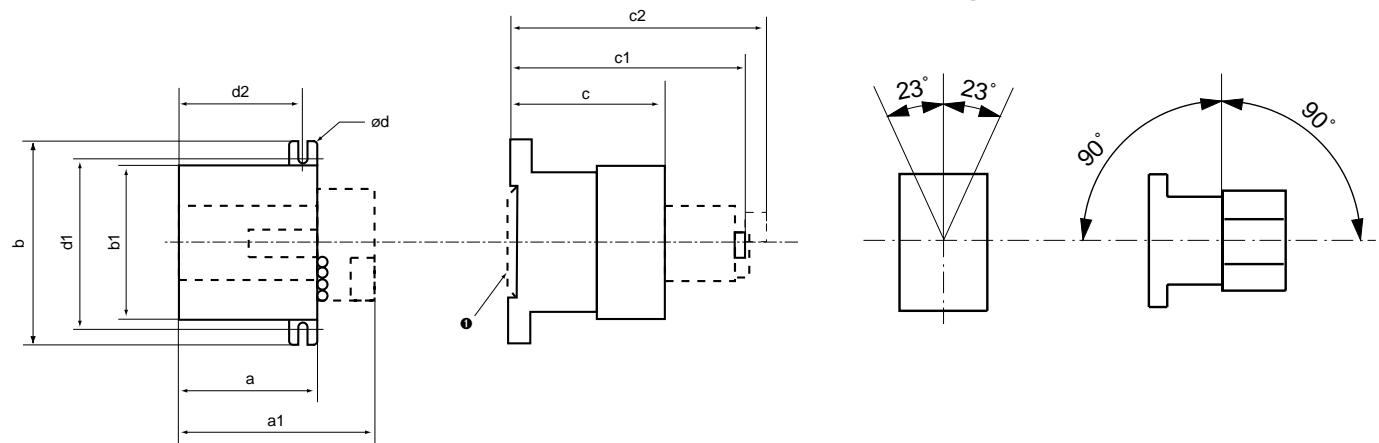

Type	a	a1	b	b1	c	c1	c2	ød	d1	d2	
100-M	45	67	56	47	48	74	77	4	50	40	❶

Contactor with ...	[mm]
Mechanical interlock	a+a
Auxiliary contact block	c1
Timer	front-mounted: c2 side-mounted: a1
Neutral terminal	side-mounted: a+20
Suppressor module	c2
Label holder	c..+5

❶ Mountable on 35 mm DIN Rail EN50 022
(Combined DIN/C Rail mounting not possible when using mechanical latch or mechanical interlock)

Bulletin 100-C

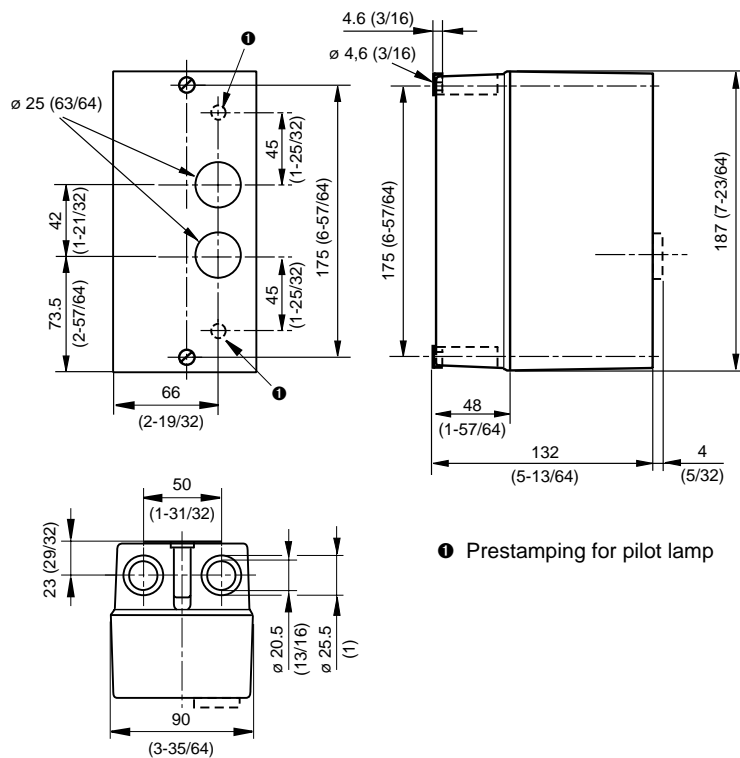

Contactors

Dimensions

Bulletin 100-C

Dimensions are shown in millimetres and (inches)

Mounting Position

AC Control

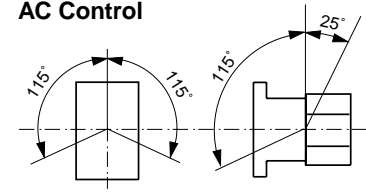

DC Control

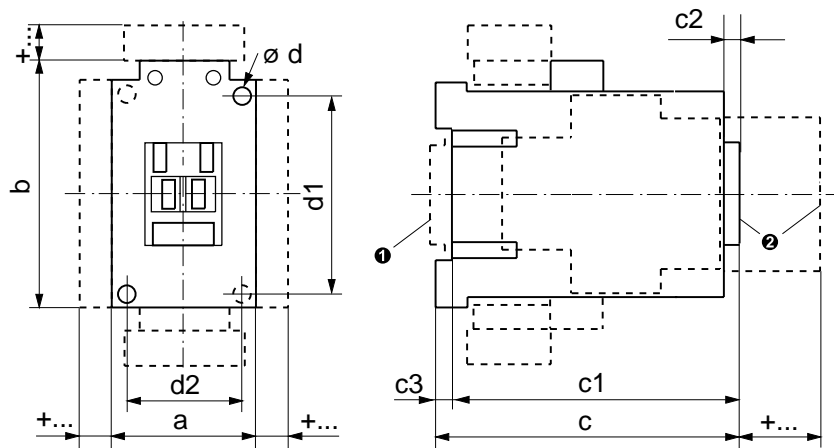
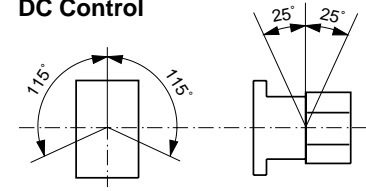

4

AC Control

Type	a	b	c	c1	c2	c3	ød	d1	d2	
100-C09 ... 100-C23	45 (1- 25/32)	81 (3- 3/16)	80.5 (3- 11/64)	75.5 (3- 3/32)	6 (1/4)	4.5 (3/16)	2 pcs each 4.5 (2 pcs each 3/16)	60 (2- 23/64)	35 (1- 25/64)	①
100-C30 ... 100-C37	45 (1- 25/32)	81 (3- 3/16)	97.5 (4)	92.6 (3- 49/64)	6.5 (17/64)	4.5 (3/16)	2 pcs each 4.5 (2 pcs each 3/16)	60 (2- 23/64)	35 (1- 25/64)	①
100-C43	54 (2- 1/8)	81 (3- 3/16)	100.5 (4- 7/64)	95.6 (3- 7/8)	6.5 (17/64)	5 (13/64)	2 pcs each 4.5 (2 pcs each 3/16)	60 (2- 23/64)	45 (1- 25/32)	①
100-C60 ... 100-C85	72 (2- 53/64)	122 (4- 51/64)	117 (4- 49/64)	111.5 (4- 35/64)	8.5 (21/64)	5.5 (7/32)	4 pcs each 5.4 (4 pcs each 7/32)	100 (3- 15/16)	55 (2- 11/64)	①

DC Control

Type	a	b	c	c1	c2	c3	ød	d1	d2	
100-C09Z ... 100-C16Z	45 (1- 25/32)	81 (3- 3/16)	106.5 (4- 3/16)	101.5 (4)	6 (1/4)	4.5 (3/16)	2 pcs each 4.5 (2 pcs each 3/16)	60 (2- 23/64)	35 (1- 25/64)	①
100-C23Z	45 (1- 25/32)	81 (3- 3/16)	123.5 (4- 55/64)	119 (4- 43/64)	6 (1/4)	4.5 (3/16)	2 pcs each 4.5 (2 pcs each 3/16)	60 (2- 23/64)	35 (1- 25/64)	①
100-C30Z ... 100-C37Z	45 (1- 25/32)	81 (3- 3/16)	141.5 (5- 37/64)	136.5 (5- 3/8)	6.5 (17/64)	4.5 (3/16)	2 pcs each 4.5 (2 pcs each 3/16)	60 (2- 23/64)	35 (1- 25/64)	①
100-C43Z	54 (2- 1/8)	81 (3- 3/16)	144.5 (5- 11/16)	140 (5- 33/64)	6.5 (17/64)	5 (13/64)	2 pcs each 4.5 (2 pcs each 3/16)	60 (2- 23/64)	45 (1- 25/32)	①
100-C60Z ... 100-C85Z	72 (2- 53/64)	122 (4- 51/64)	117 (4- 49/64)	111.5 (4- 35/64)	8.5 (21/64)	5.5 (7/32)	4 pcs each 5.4 (4 pcs each 7/32)	100 (3- 15/16)	55 (2- 11/64)	①

Accessories

Contactor with ...	AC Control		DC Control	
	[mm]	[inches]	[mm]	[inches]
Auxiliary contact block, front-mounted	c/c1 + 39	c/c1 + 1- 37/64	c/c1 + 39	c/c1 + 1- 37/64
Auxiliary contact block, side-mounted	a + 9	a + 23/64	a + 9	a + 23/64
Pneumatic timing module	c/c1 + 58	c/c1 + 2- 23/64	—	—
Solid-State timing module (100-ETA)	b + 24	b + 15/16	b + 24	b + 15/16
Solid-State timing module (100-ETB / 100-ETY)	b + 24	b + 15/16	—	—
Mechanical interlock	a + 9	a + 23/64	a + 9	a + 23/64
Mechanical latch	c/c1 + 61	c/c1 + 2- 31/64	—	—
Interface	b + 9	b + 23/64	—	—
Suppressor module	b + 3	b + 1/8	b + 3	b + 1/8
② Marking with				
sheets of labels	+ 0	+ 0	+ 0	+ 0
marking sheets with cover	+ 0	+ 0	+ 0	+ 0
label holder for System V4/V5	+ 5.5	+ 7/32	+ 5.5	+ 7/32
label holder for System Bul. 1492W	+ 5.5	+ 7/32	+ 5.5	+ 7/32

① Mountable on 35 mm DIN Rail EN 50 022

Bulletin 100S-C

Dimensions are shown in millimetres and (inches)

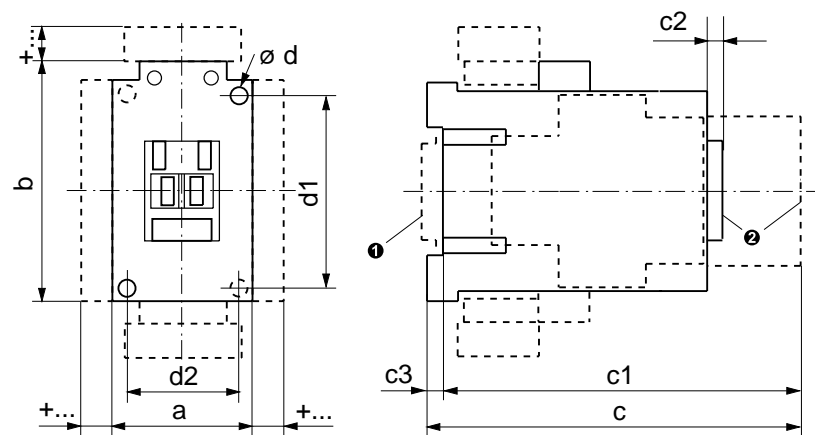

Mounting Position

AC Control

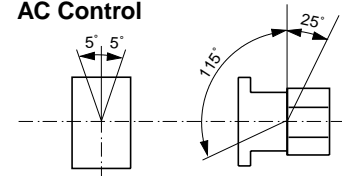

DC Control

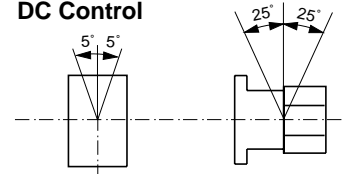

AC Control

Type	a	b	c	c1	c2	c3	ød	d1	d2	
100S-C09...100S-C23	45 (1- 25/32)	81 (3- 3/16)	119.5 (4-3/4)	114.5 (4-43/64)	6 (1/4)	4.5 (3/16)	2 pcs each 4.5 (2 pcs each 3/16)	60 (2- 23/64)	35 (1- 25/64)	①
100S-C30...100S-C37	45 (1- 25/32)	81 (3- 3/16)	136.5 (5-37/64)	131.6 (5-11/32)	6.5 (17/64)	4.5 (3/16)	2 pcs each 4.5 (2 pcs each 3/16)	60 (2- 23/64)	35 (1- 25/64)	①
100S-C43	54 (2- 1/8)	81 (3- 3/16)	139.5 (5-11/16)	134.6 (5-29/64)	6.5 (17/64)	5 (13/64)	2 pcs each 4.5 (2 pcs each 3/16)	60 (2- 23/64)	45 (1- 25/32)	①
100S-C60...100S-C85	72 (2- 53/64)	122 (4- 51/64)	156 (6-11/32)	150.5 (6-1/8)	8.5 (21/64)	5.5 (7/32)	4 pcs each 5.4 (4 pcs each 7/32)	100 (3- 15/16)	55 (2- 11/64)	①

DC Control

Type	a	b	c	c1	c2	c3	ød	d1	d2	
100S-C09Z...100S-C16Z	45 (1- 25/32)	81 (3- 3/16)	145.5 (5-49/64)	140.5 (5-37/64)	6 (1/4)	4.5 (3/16)	2 pcs each 4.5 (2 pcs each 3/16)	60 (2- 23/64)	35 (1- 25/64)	①
100S-C23Z	45 (1- 25/32)	81 (3- 3/16)	162.5 (6-7/16)	158 (6-1/4)	6 (1/4)	4.5 (3/16)	2 pcs each 4.5 (2 pcs each 3/16)	60 (2- 23/64)	35 (1- 25/64)	①
100S-C30Z...100S-C37Z	45 (1- 25/32)	81 (3- 3/16)	180.5 (7-5/32)	175.5 (6-61/64)	6.5 (17/64)	4.5 (3/16)	2 pcs each 4.5 (2 pcs each 3/16)	60 (2- 23/64)	35 (1- 25/64)	①
100S-C43Z	54 (2- 1/8)	81 (3- 3/16)	183.5 (7-17/64)	179 (7-3/32)	6.5 (17/64)	5 (13/64)	2 pcs each 4.5 (2 pcs each 3/16)	60 (2- 23/64)	45 (1- 25/32)	①
100S-C60D...100S-C85D	72 (2- 53/64)	122 (4- 51/64)	156 (6-11/32)	150.5 (6-1/8)	8.5 (21/64)	5.5 (7/32)	4 pcs each 5.4 (4 pcs each 7/32)	100 (3- 15/16)	55 (2- 11/64)	①

Accessories

Contactor with ...	AC C control		DC Control		
	[mm]	[inches]	[mm]	[inches]	
Auxiliary contact block, side-mounted	a + 9	a + 23/64	a + 9	a + 23/64	
Solid-state timing module (100-ETA)	b + 24	b + 15/16	b + 24	b + 15/16	
Solid-state timing module (100-ETB / 100-ETY)	b + 24	b + 15/16	—	—	
Mechanical interlock	a + 9	a + 23/64	a + 9	a + 23/64	
Interface	b + 9	b + 23/64	—	—	
Suppressor Module	b + 3	b + 1/8	b + 3	b + 1/8	
② Marking with	sheets of labels	+ 0	+ 0	+ 0	
	marking sheets with cover	+ 0	+ 0	+ 0	
	label holder for System V4/V5	+ 5.5	+ 7/32	+ 5.5	+ 7/32
	label holder for System Bul. 1492W	+ 5.5	+ 7/32	+ 5.5	+ 7/32

① Mountable on 35 mm DIN Rail EN 50 022

Contactors

Dimensions

Bulletin CAB6

Dimensions in millimetres

Mounting Position

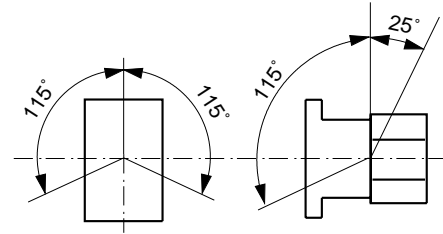
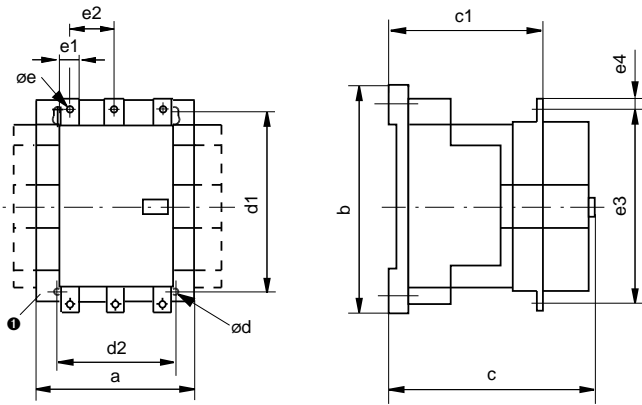

4

Type	a	b	c	c1	ød	d1	d2	øe	e1	e2	e3	e4
CAB6-85, CAB6-105	120	170	156	110.5	5.2	145	100	M6	16	38.5	147	8
CAB6-105-EI...CAB6-170-EI, CAB6-140	120	170	156	110.5	5.2	145	100	M8	20	39	160	10
CAB6-210-EI ...CAB6-420-EI	155	205	180	110.5	6.5	180	130	M10	25	48	193	12.5

Contactor with ...		[mm]
Auxiliary contact block	P1 + P2 + P3, or + P4	a a + each 13.5
Mechanical interlock		a + a
Terminal block	HB 1 HB 2 HB 3	b + each 7 b + each 7 b + each 8.5
Suppressor module	HA 1 HA 2 HA 3	b + each 20...40 b + each 15...40 b + each 11...50
Label holder		c... + 5

❶ No change of base dimensions with 1 or 2 auxiliary contact blocks (P1, P2).
With 3 or 4 auxiliary contact blocks (P3, P4), add 13.5 mm each.

Bulletin CAB6 Mounting Plates

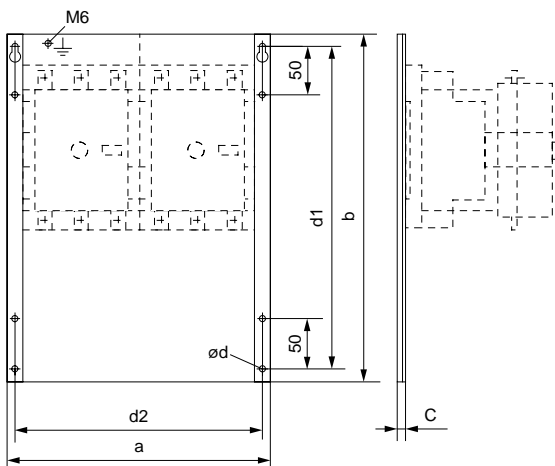

Type	a	b	c	ød	d1	d2	[kg]
CAB6-105-PS	150	340	6	6.5	315	135	1
CAB6-105-PU	270	340	6	6.5	315	255	1.8
CAB6-105-PY	390	340	6	6.5	315	275	2.5
CAB6-250-PS	188	380	6	6.5	315	173	1.4
CAB6-250-PU	344	380	6	6.5	315	328.5	2.6
CAB6-250-PY	499	380	6	6.5	315	484	3.75

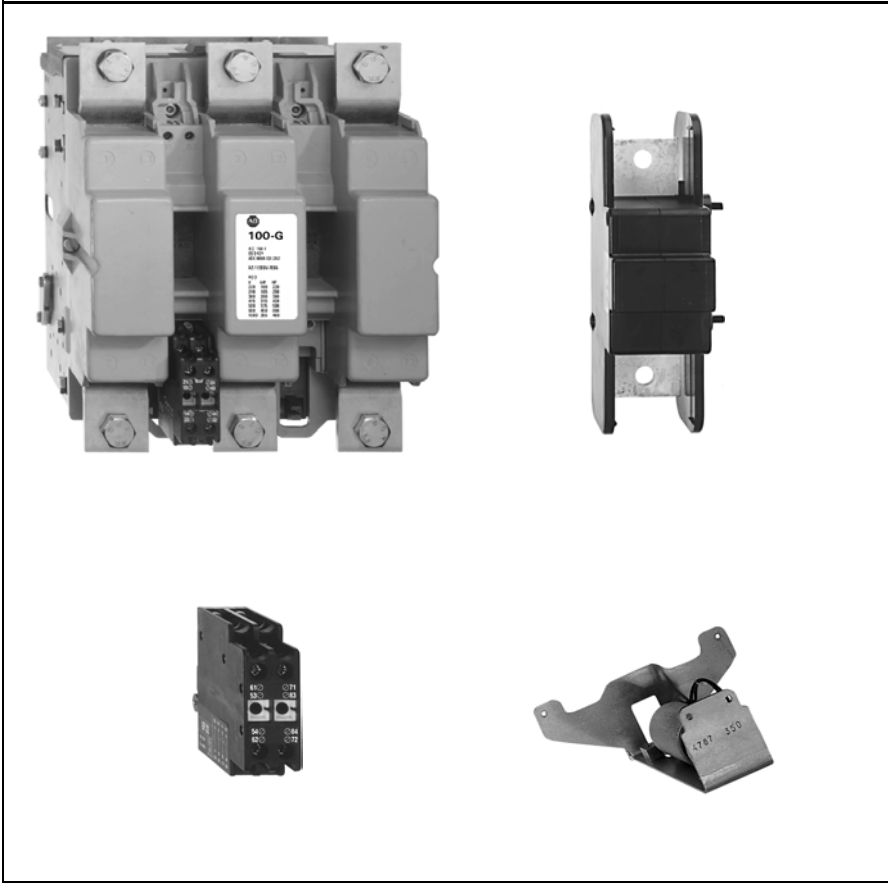

**Bulletin 100-G
 Contactors**

- **315 ... 710 kW**
 (550 ... 1200 A)

Table of Contents

Description	Page	Description	Page
Overview	4-2	Specifications	
Product Selection	4-66	Performance Data / Characteristics	4-69
Accessories		Weight	4-72
Modules	4-67	Standards and Approvals	4-74
Renewal Parts	4-68	Electrical Life	4-75
		Permissible Switching Rate	4-76
		Dimensions	4-78



AC, DC Control

AC-1 [A]	Switching of 3-phase Motors AC-2, AC-3								EN Basic Number		Cat. No.	PQ
	[kW] ❶				[A]				— —	— /		
40 °C	230 V	400 V	500 V	690 V	230 V	400 V	500 V	690 V	N.O.	N.C.		
760	160	315	400	500	550	550	550	500	2	2	100-G550⊗22	1
1000	220	400	500	630	700	700	700	630	2	2	100-G700⊗22	
1100	280	500	630	710	860	860	860	700	2	2	100-G860⊗22	
1200	335	600	750	900	1000	1000	1000	860	2 ❷	2	100-G1000⊗12	
1350	400	710	850	1000	1200	1200	1200	1000	2 ❷	2	100-G1200⊗12	

❷ 1 auxiliary contact (1 N.O. contact used in control circuit)

⊗ Voltage Suffix Code

For Use with		100-110 V	110-120 V	200-220 V	220-240 V	345-380 V	380-415 V	400-440 V	440-480 V
100-G550...100-G860	50/60 Hz	—	KD	—	KF	—	KN	—	KB
	DC	KD	—	KF	—	KN	—	KB	—

For Use with		110-115 V	110 V	200-230 V	220 V	240 V	380-400 V	440 V
100-G1000...100-G1200	50/60 Hz	KD	—	KF	—	KA	KN	KB
	DC	—	ZD	—	ZA	—	—	—





Price Adder for:	Type	Available Control Voltages	No Surcharge
Special control voltages	100-G550...100-G860	24...600 V 50/60 Hz, 24...440 VDC	> 25 pieces
	100-G1000, 100-G1200	48...600 V 50/60 Hz, 48...440 VDC	

❶ Power ratings: Preferred values according to IEC 60072-1

PQ = Package Quantity

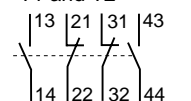
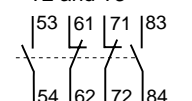
Accessories - Page 4-67
 Specifications - Page 4-69
 Dimensions - Page 4-78

Modules

	Description	For Use with	Cat. No.	PQ
	Auxiliary Contact Blocks Up to 2 auxiliary contact blocks per contactor. With the EF22 auxiliary switch block, the switching point of the normally closed contact in relation to the main contacts can be altered. See instructions included with the auxiliary contact block.			
	<div style="display: flex; justify-content: space-around;"> <div style="text-align: center;"> <p>mounted between T1 and T2</p>  </div> <div style="text-align: center;"> <p>mounted between T2 and T3</p>  </div> </div>	100-G550...100-G860	100-EF22	1
	Up to 4 auxiliary contact blocks per contactor. 1 make + 1 break 1 make + 1 late break	100-G1000, 100-G1200	100-EB11 100-EB11DC	
	Fourth Main Contact Pole Left- or right-side mountable	I_{th} AC-1 500 A 100-G550 100-G700, 100-G860	100-NP500-5 100-NP500-6	1
		I_{th} AC-1 900 A 100-G700, 100-G860 100-G1000, 100-G1200	100-NP1000-6 100-NP1000-7	
	Mechanical Latch Mechanical life: 0.5 million operations Direct and impulse contact control Direct and impulse contact control	100-G550 100-G700, 100-G860	100-FLAM5⊗ 100-FLAM6⊗	1
	Mechanical Interlock The interlocks are delivered factory-mounted for 2 contactors mounted side by side	100-G550 / 100-G550	100-MC00-5H	1
		100-G550 / 100-G700, 100-G860	100-MC00-56H	
		100-G700, 100-G860 / 100-G700, 100-G860	100-MC00-6H	
		100-G700, 100-G860 / 100-G1000, 100-G1200	100-MC00-67H	
	for 2 contactors stacked vertically	100-G1000, 100-G1200 / 100-G1000, 100-G1200	100-MC00-7H	1
		100-G550 / 100-G550	100-MC00-5V	
		100-G550 / 100-G700, 100-G860	100-MC00-56V	
		100-G700, 100-G860 / 100-G700, 100-G860	100-MC00-6V	
		100-G700, 100-G860 / 100-G1000, 100-G1200	100-MC00-67V	
100-G1000, 100-G1200 / 100-G1000, 100-G1200	100-MC00-7V			





⊗ Voltage Suffix Code

For Use with			110-120 V	220-240 V	380-415 V	440-480 V
100-G550...100-G1200		50/60 Hz	KD	KF	KN	KB

Price Adder for:	Type	Available Control Voltages	No Surcharge
Special control voltages	100-FLAM	12...550 V 50/60 Hz upon request	> 25 pieces

PQ = Package Quantity

Renewal Parts

	Description	For Use with	Cat. No.	PQ	
	Arc Chambers for Contactors For 3 poles	100-G550	100-AC550	1	
		100-G700, 100-G860	100-AC860		
	For 1 pole	100-G1000	100-AC1000	1	
		100-G1200	100-AC1200		
	Main Contacts for Contactors Set for 1 pole	100-G550	100-CP550	1	
		100-G700	100-CP700		
		100-G860	100-CP860		
		100-G1000	100-CP1000		
		100-G1200	100-CP1200		
	Coils and Supply Modules for Contactors Only available as renewal part	Coils ⑤ AC/DC control	100-G550 100-G700...100-G860 100-G1000...100-G1200	see Table below	1
		Supply Module AC/DC control	100-G550 100-G700...100-G860 100-G1000...100-G1200	see Table below	

Voltage Suffix Codes

100-G

AC Standard Control Voltages	DC Standard Control Voltages	AC / DC Coil Code	100-G550		100-G700... 100-G860		PQ	AC Standard Control Voltages	AC / DC Coil Code	100-G1000... 100-G1200		PQ
			Coil ⑤ Cat. No.	Supply module Cat. No.	Coil ⑤ Cat. No.	Supply module Cat. No.				Coil ⑤ Cat. No.	Supply module Cat. No.	
50/60 Hz								50/60 Hz				
110...120 V	100...110 V	KD	TX734	TXS734	TY734	TYS734	1	110...115 V	KD	TZ734	TZS734	1
220...240 V	200...220 V	KF	TX747	TXS747	TY747	TYS747		220...230 V	KF	TZ747	TZS747	
380...415 V	345...380 V	KN	TX779	TXS779	TY779	TYS779		380...400 V	KN	TZ779	TZS779	
440...480 V	400...440 V	KB	TX780	TXS780	TY780	TYS780		440 V	KB	TZ780	TZS780	

⑤ Coils sold in pairs

Price Adder for:	Type	Available Control Voltages	No Surcharge
Special control voltages	100-G550...100-G860	24...600 V 50/60 Hz, 24...440 VDC	>25 pieces
	100-G1000, 100-G1200	48...600 V 50/60 Hz, 48...440 VDC	

PQ = Package Quantity

IEC Performance Data

	100-G550	100-G700	100-G860	100-G1000	100-G1200
AC-1, Three-phase Switching					
Ambient temperature 40 °C					
I_e ≤ 690 V [A]	760	1 000	1 100	1 200	1 350
230 V [kW]	303	398	438	478	538
240 V [kW]	316	416	457	499	561
400 V [kW]	527	693	762	831	935
415 V [kW]	546	719	791	863	970
500 V [kW]	658	866	953	1 039	1 169
690 V [kW]	908	1 195	1 315	1 434	1 613
1 000 V [kW]	1 316	1 732	1 905	—	—
Ambient temperature 60 °C					
I_e ≤ 690 V [A]	605	800	870	960	1 085
230 V [kW]	241	319	347	382	432
240 V [kW]	251	333	362	399	451
400 V [kW]	419	554	603	665	752
415 V [kW]	435	575	625	690	780
500 V [kW]	524	693	753	831	940
690 V [kW]	723	956	1 040	1 147	1 297
1 000 V [kW]	1 048	1 386	1 507	—	—
Constant Current - UL/CSA					
General Purpose Rating 40 °C [A]					
	520	700	810	—	1 215
Switching of 3-phase Motors					
AC-2, AC-3, AC-4					
230/240 V [A]	550	700	860	1 000	1 200
400/415 V [A]	550	700	860	1 000	1 200
500 V [A]	550	700	860	1 000	1 200
690 V [A]	500	630	700	860	1 000
230 V ② [kW]	160	220	280	335	400
240 V ② [kW]	185	220	300	335	400
400 V ② [kW]	315	400	500	600	710
415 V ② [kW]	315	425	530	630	750
500 V ② [kW]	400	500	630	750	850
690 V ② [kW]	500	630	710	900	1 000
AC-4 at 200 000 operations					
230/240 V [A]	140	180	210	260	300
400/415 V [A]	140	180	210	260	300
230 V [kW]	45	57	67	83	97
240 V [kW]	47	60	70	87	101
400 V [kW]	78	101	118	146	170
415 V [kW]	81	105	122	151	176
AC-4, Squirrel-cage motors with reversing and jogging at 20 000 (25 000), operations					
230/240 V [A]	360	430	520	(630)	(700)
400/415 V ① [A]	350	420	520	(630)	(700)
230 V [kW]	116	139	170	(205)	(228)
240 V [kW]	111	151	177	(214)	(245)
400 V [kW]	198	238	295	(357)	(414)
415 V [kW]	206	247	300	(359)	(424)
Switching of 3-phase Motors - UL/CSA					
60 Hz/60 °C					
200 V [A]	414	552	692	—	1 185
230 V [A]	360	602	722	—	1 130
460 V [A]	414	590	708	—	1 062
575 V [A]	336	472	576	—	864
200 V [HP]	150	200	250	—	450
230 V [HP]	150	250	300	—	450
460 V [HP]	350	500	600	—	900
575 V [HP]	350	500	600	—	900

① At rated voltage 415V and rated current: Life span -25 %
 ② Power ratings: Preferred values according to IEC 60072-1

IEC Performance Data

				100-G550	100-G700	100-G860	100-G1000	100-G1200
Rated making capacity								
AC-4	I_e	≤ 415 V	[A]	5 500	7 000	8 600	10 000	12 000
		500 V	[A]	5 500	7 000	8 600	10 000	12 000
		690 V	[A]	5 000	6 300	7 000	8 600	10 300
Rated breaking capacity								
AC-4	I_e	≤ 240 V	[A]	5 500	7 000	8 000	8 000	9 600
		400 V	[A]	4 500	5 600	6 900	8 000	9 600
		415 V	[A]	4 500	5 600	6 900	8 000	9 600
		500 V	[A]	4 500	5 600	6 900	8 000	9 600
		690 V	[A]	4 500	5 600	6 000	6 900	8 000
Star-Delta Starting								
50 Hz		≤ 500 V	[A]	953	1 212	1 490	1 732	2 078
		690 V	[A]	831	1 091	1 195	1 490	1 732
		230 V	[kW]	310	395	485	565	677
		240 V	[kW]	324	412	507	589	707
		400 V	[kW]	540	717	882	1 025	1 250
		415 V	[kW]	561	745	915	1 088	1 278
		500 V	[kW]	705	897	1 102	1 309	1 538
		690 V	[kW]	883	1 138	1 247	1 554	2 078
		1 000 V	[kW]	615	866	970	—	—
Star-Delta Starting								
60 Hz		230 V	[A]	250	450	500	650	750
		460 V	[A]	600	800	1 000	1 300	1 500
		575 V	[A]	600	800	1 000	1 500	1 500
Short-circuit Protection of Contactors without Overload Relay								
Fuse gG (aM) Type «1» coordination per IEC 947-4-1								
		500 V	[A]	(630)	800	1 000	1 000	1 250
		690 V	[A]	(630)	800	1 000	1 000	1 000
Switching of Three-phase Capacitor Motors								
Inductivity of dispatching between parallel switched capacitors: min. 6 μH								
Single capacitors 40 °C								
		230 V	[kVar]	180	220	250	290	330
		240 V	[kVar]	200	250	300	325	360
		400 V	[kVar]	320	400	450	500	575
		415 V	[kVar]	350	430	500	550	630
		500 V	[kVar]	450	520	600	660	750
		690 V	[kVar]	580	700	800	875	1 000
	55 °C	230 V	[kVar]	150	180	220	275	325
		240 V	[kVar]	170	200	260	300	350
		400 V	[kVar]	280	330	400	460	550
		415 V	[kVar]	300	360	450	500	600
		500 V	[kVar]	360	420	540	600	720
		690 V	[kVar]	500	580	720	800	950
Control capacitors 40 °C								
		230 V	[kVar]	180	220	250	290	330
		240 V	[kVar]	200	250	300	325	360
		400 V	[kVar]	320	400	450	500	575
		415 V	[kVar]	350	430	500	550	630
		500 V	[kVar]	450	520	600	660	750
		690 V	[kVar]	580	700	800	875	1 000
	55 °C	230 V	[kVar]	150	180	220	275	325
		240 V	[kVar]	170	200	260	300	350
		400 V	[kVar]	280	330	400	460	550
		415 V	[kVar]	300	360	450	500	600
		500 V	[kVar]	360	420	540	600	720
		690 V	[kVar]	500	580	720	800	950

IEC Performance Data

	100-G550	100-G700	100-G860	100-G1000	100-G1200
Switching of DC Loads					
Switching of non- or slightly inductive loads, resistance furnaces DC-1 at 60 °C					
1-pole 24/48 V [A]	645	760	930	1 020	1 150
2 Poles in series 24/48 V [A]	645	760	930	1 020	1 150
3 Poles in series 24/48 V [A]	645	760	930	1 020	1 150
110 V [A]	480	560	630	800	900
220 V [A]	315	400	450	500	600
Shunt Motors					
Starting, regenartive brake, reverse, Jogging DC-3, 60 °C					
3 Pole in Serie 24/48 V [A]	605	800	870	960	1 085
Series-characteristic Motors					
Starting, regenartive brake, reverse, Jogging DC-5, 60 °C					
3 Pole in Serie 24/48 V [A]	605	800	870	960	1 085
Switching of Lamps					
Electric discharge lamps AC-5a					
Single compensated:					
open [A]	450	570	700	850	1 000
close [A]	360	460	550	660	800
Incandescent lamps AC-5b					
Electrical Lifespan					
~ 100 000 operations [A]	315	440	500	560	630
Switching of Transformers AC-6a					
Switch-on peak load = n Rated transformer current					
Rated transformer current [A]	259	330	405	470	570
n = 30 400 VAC [kVA]	248	315	390	450	540
500 VAC [kVA]	248	315	390	450	540
690 VAC [kVA]	225	284	315	450	540
n = 20 [kVA]	389	495	608	700	850
n = 15 [kVA]	517	660	810	945	1 130
Short-time Withstand I_{CW}, 60 °C					
1 s [A]	5 500	7 000	8 000	10 000	12 000
4 s [A]	5 500	7 000	8 000	10 000	12 000
10 s [A]	4 400	5 600	6 900	8 000	9 600
15 s [A]	3 800	5 000	6 000	7 400	8 500
60 s [A]	2 300	2 800	3 400	4 000	4 800
240 s [A]	1 300	1 800	2 000	2 300	2 700
900 s [A]	850	1 150	1 350	1 600	1 900
Minimum Cooling Time at Zero Current [Min.]					
	60	60	60	60	60
Resistance and Power Dissipation					
Main current circuit resistance [mΩ]	0.11	0.1	0.08	0.06	0.05
Power dissipation of all at I_e AC-3 [W]	99	147	177	300	318
Total power dissipation at I_e AC-3					
AC control [W]	110	172	202	370	388
DC control [W]	109	169	199	360	378

Bulletin 100-G
Contactors
Specifications

IEC Performance Data

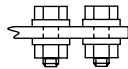
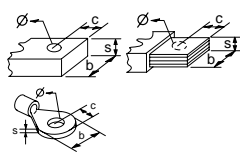
			100-G550	100-G700	100-G860	100-G1000	100-G1200
Lifespan mechanical	AC control	[Mio. operations]	5			1	
	DC control	[Mio. operations]	5			1	
	AC-3 (400 V)	[Mio. operations]	0.6				
Weight	AC control	[kg]	13.8	26.4	28.4	50.3	53.4
	DC control	[kg]					
Connections Main Contacts							
Terminal type							
Connections Contactor	[mm ²]		6x40	5x50	8x50	10x50	10x60
Hole diameter	[mm]		(1) x ø13		(1) x ø15	(2) x ø17	
	b max.	[mm]	50	60	60	60	60
	c max.	[mm]	25	25	25	25	25
	s max.	[mm]	2 x 5	2 x 5	2 x 6	2 x 6	2 x 8
	Ø max.	[mm]	12.5	13	15	2 x 13	2 x 13
Recommended torque	Nm]		50	60	75	90	90
With terminal lug			100-LG5	100-LG6	100-LG6	100-LG7	100-LG7
Wire cross-section acc. to EC 60947-1	[mm ²]		(2) x 35...300	(3) x 35...300	(3) x 35...300	(4) x 35...300	(4) x 35...300
Wire cross-section acc. to UL/CSA	[AWG]		(2) x No. 2...600 MCM	(3) x No. 2...600 MCM	(3) x No. 2...600 MCM	(4) x No. 2...600 MCM	(4) x No. 2...600 MCM
Auxiliary contact	[mm ²]				(2) x 4		
Coils	[mm ²]				(2) x 4		

4

Control Circuits

			100-G550	100-G700	100-G860	100-G1000	100-G1200	
Operating Limits								
AC- 50 Hz	pick-up	[x U _s]	0.85...1.1					
	dropout	[x U _s]	0.2...0.5	0.15...0.5		0.3...0.6		
AC- 60 Hz	pick-up	[x U _s]	0.85...1.1					
	dropout	[x U _s]	0.2...0.5	0.15...0.5		0.3...0.6		
DC control	pick-up	[x U _s]	0.85...1.1					
	dropout	[x U _s]	0.2...0.5	0.15...0.5		0.3...0.6		
Pick-up and Holding Power								
AC- 50 Hz	pick-up	[VA]	800...950	1 350...1600		2400		
	holding	[VA/W]	9...11	21...25		70		
AC- 60 Hz	pick-up	[VA/W]	800...950	1 350...1 600		2400		
	holding	[VA/W]	9...11	21...25		70		
DC control	pick-up	[W]	700...850	1 300...1 550		2100		
	holding	[W]	8...10	18...22		60		
Switching Delay								
AC	closing delay	[ms]	50...100				50...100	
	opening delay	[ms]	20...50 ❶ / 150...200 / 500...1 000 ❷				25...50	
DC	closing delay	[ms]	50...100				50...100	
	opening delay	[ms]	20...50 ❶ / 150...200 / 500...1 000 ❷				25...50	

❶ accelerated

❷ delayed

Auxiliary Contact Blocks

	100-G550	100-G700	100-G860	100-G1000	100-G1200
Switching of AC Loads					
AC-1 I_{th} at 40 °C [A]		16			16
at 60 °C [A]		12			12
AC-15 at rated voltage of					
120 V [A]		6			6
230 V [A]		3			3
240 V [A]		3			3
400 V [A]		2			2
415 V [A]		2			2
500 V [A]		1.5			1.5
690 V [A]		1			1
Switching of DC Loads					
DC-13 Switching of electromagnets at					
24 VDC [A]		6			6
48 VDC [A]		3			3
110 VDC [A]		1			1
220 VDC [A]		0.5			0.5
Fuse					
Short-circuit protection with no welding of contacts according to IEC 947-5					
Fuse gG [A]		10			16

General

	100-G550	100-G700	100-G860	100-G1000	100-G1200
Rated Isolation Voltage U_i					
IEC, AS, BS, SEV, VDE 0660 [V]		1 000			690
UL/CSA [V]		600			600
Testing Voltage					
1 minute according to IEC 947-4 [V]		3 500			2 500
Rated Voltage U_e					
AC 50/60 Hz [V]	230, 240, 400, 415, 500, 690			230, 240, 400, 415, 500, 690	
DC [V]				24, 48, 110, 220, 440	
Insulation Class of the Coil					
	Class «B» according to VDE 0660, table 22				
Rated Coil Frequency					
	AC 50/60 Hz, DC				
Ambient Temperature					
Storage [°C]	-40 ...+80				
Operation at rated current [°C]	-25 ...+60				
Climatic Withstand					
	Damp alternating conditions cyclical, according to DIN 50 016 and 40 046, Part 38, IEC 68				
Site Altitude					
[m]	2000 NN, according to IEC 947-1				
Protection Class					
	IP00 IEC 529 / DIN 40 050				
Shock Protection					
	Finger- and back of hand proof according to VDE 0106, Part 100				
Certifications					
	IEC 947, CEI 17-2, 17-3; UTE NF C 63-110; BS 5424; VDE 0660-1; NEMA; ICS				
Approvals					
	CE, UL Listed, Lloyd's Register of Shipping			CE, Lloyd's Register of Shipping	CE, UL Listed, Lloyd's Register of Shipping

Electrical Life

100-G

AC-3 Switching of running three-phase motors
AC-1 Non or slightly inductive loads, resistance furnaces

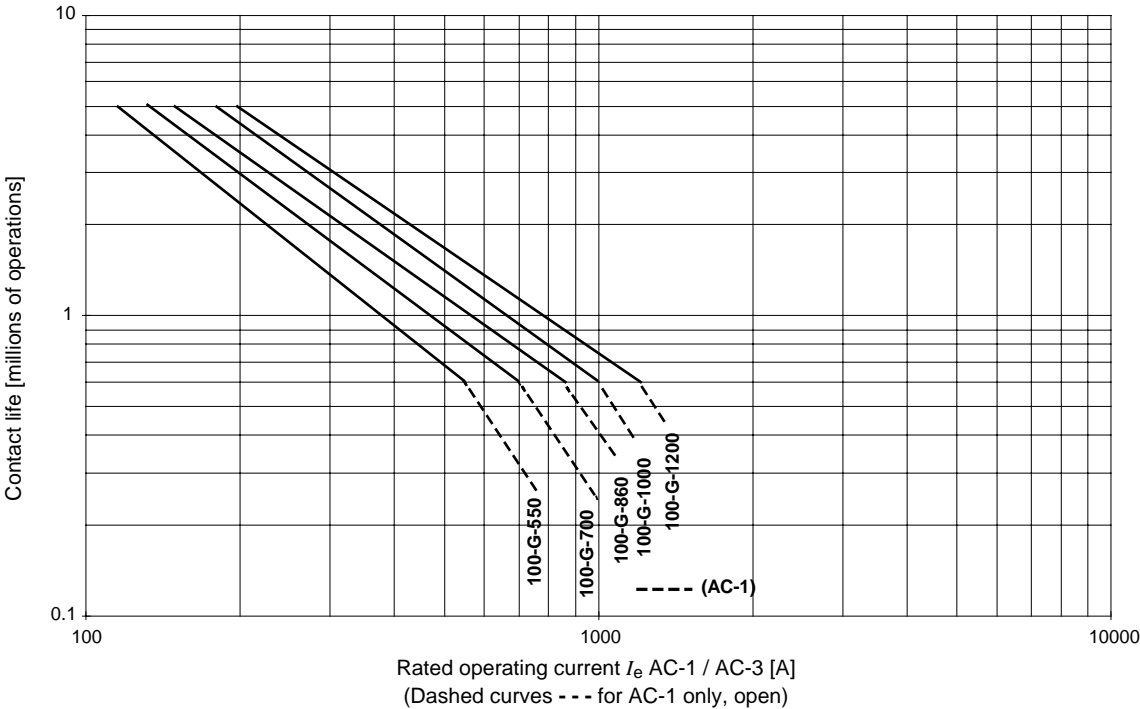

100-G

AC-4 Stepping of squirrel-cage motors

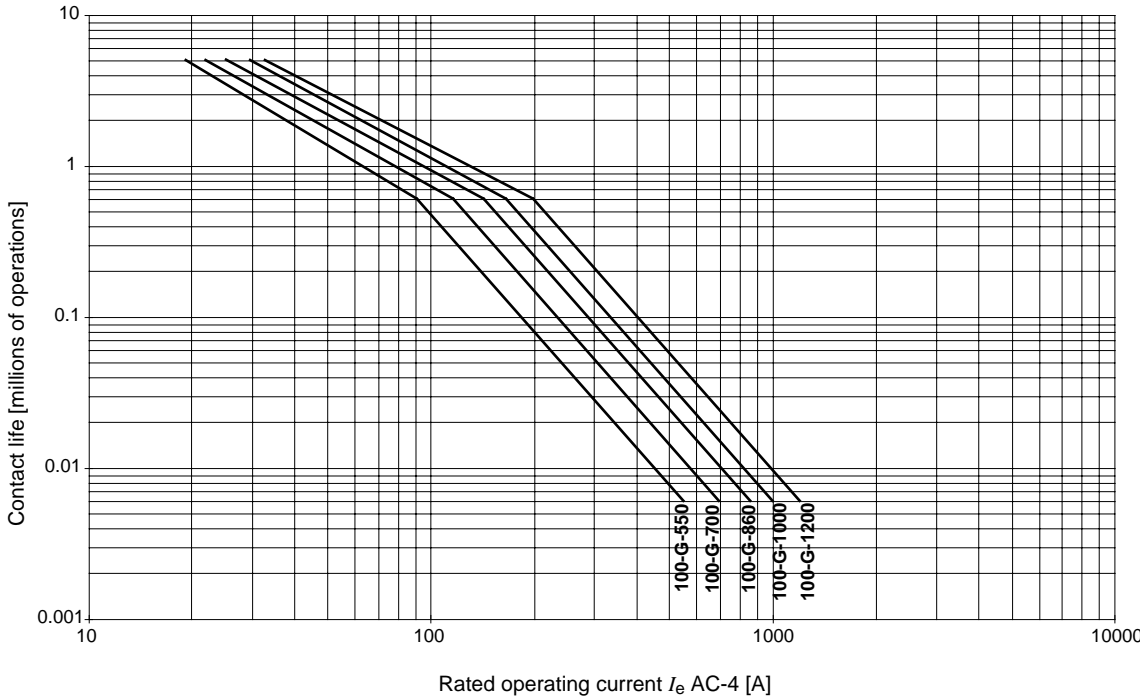

Electrical Life

100-G

AC-3 90 % Switching of running motor
 AC-4 Stepping

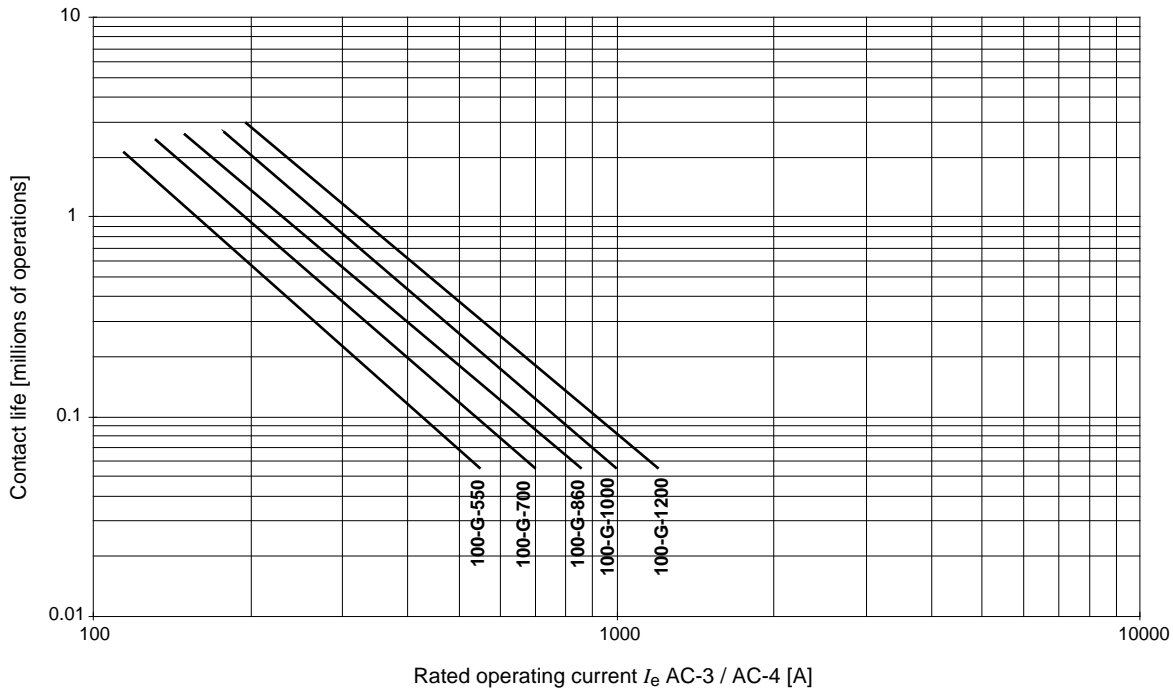

Permissible Switching Rate

100-G

Switching of running squirrel-cage motors (AC-3)
 Relative running time 40 %, starting time $t_A = 0.25$ s

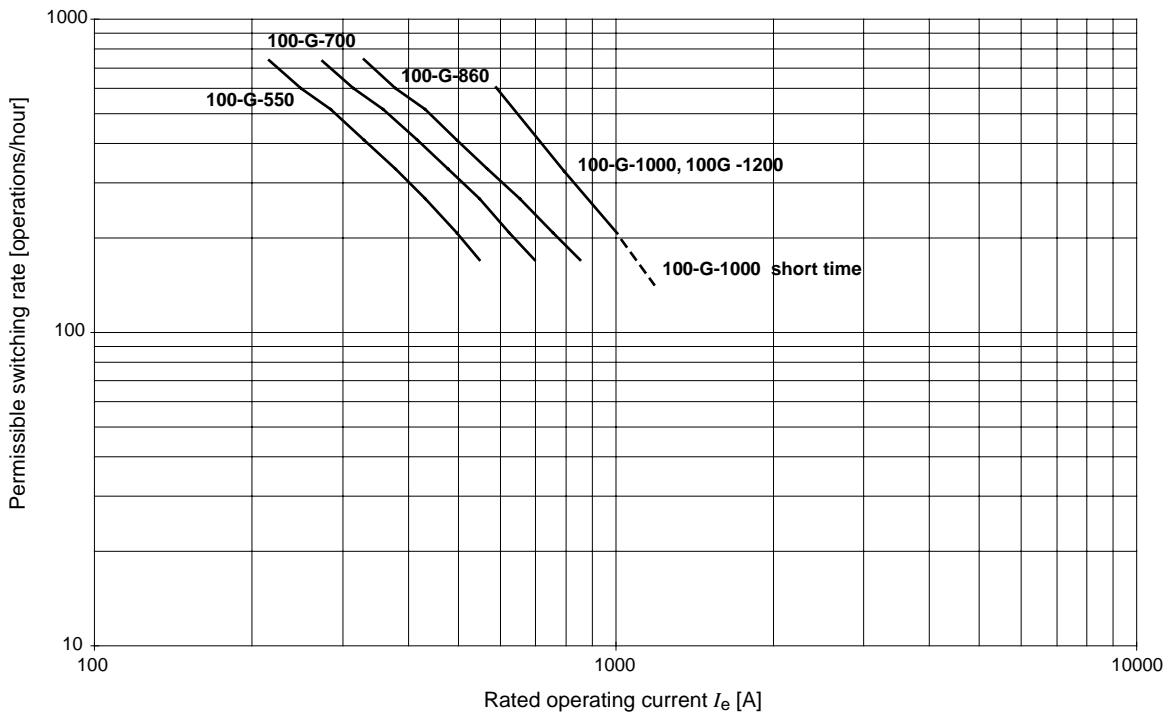

Permissible Switching Rate

100-G

Switching of running squirrel-cage motors (AC-3)
 Relative running time 40 %, starting time $t_A = 1$ s

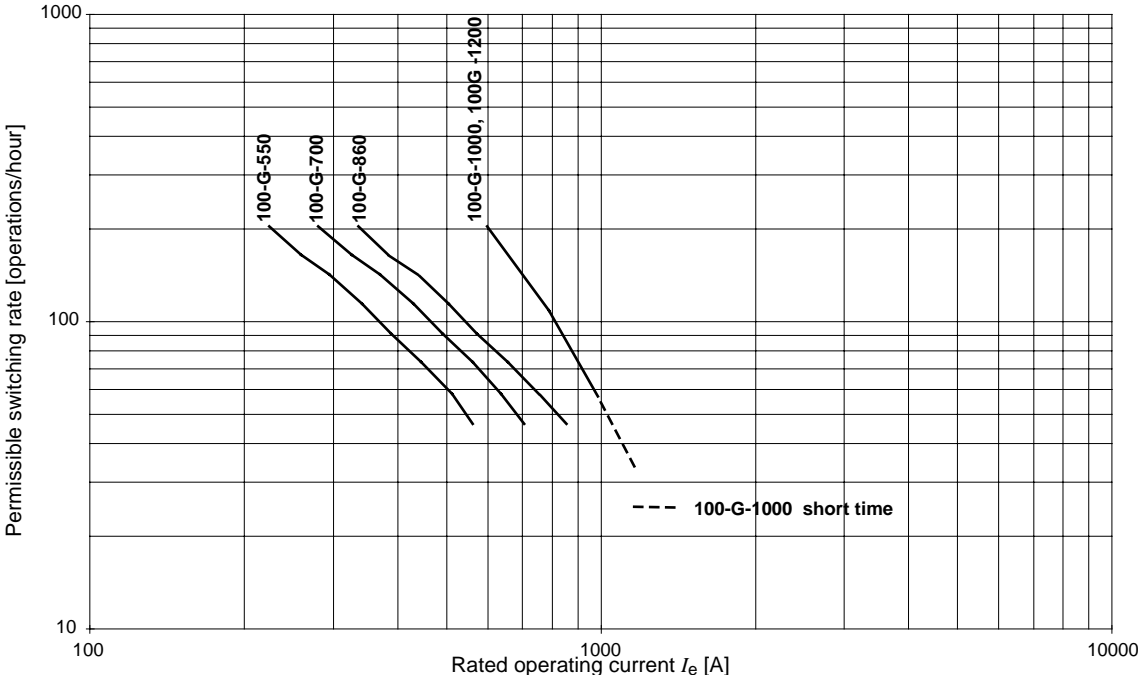

100-G

Switching of starting motors (AC-2 and AC-4)
 Starting time $t_{ED} = 1$ s ($< t_A$)

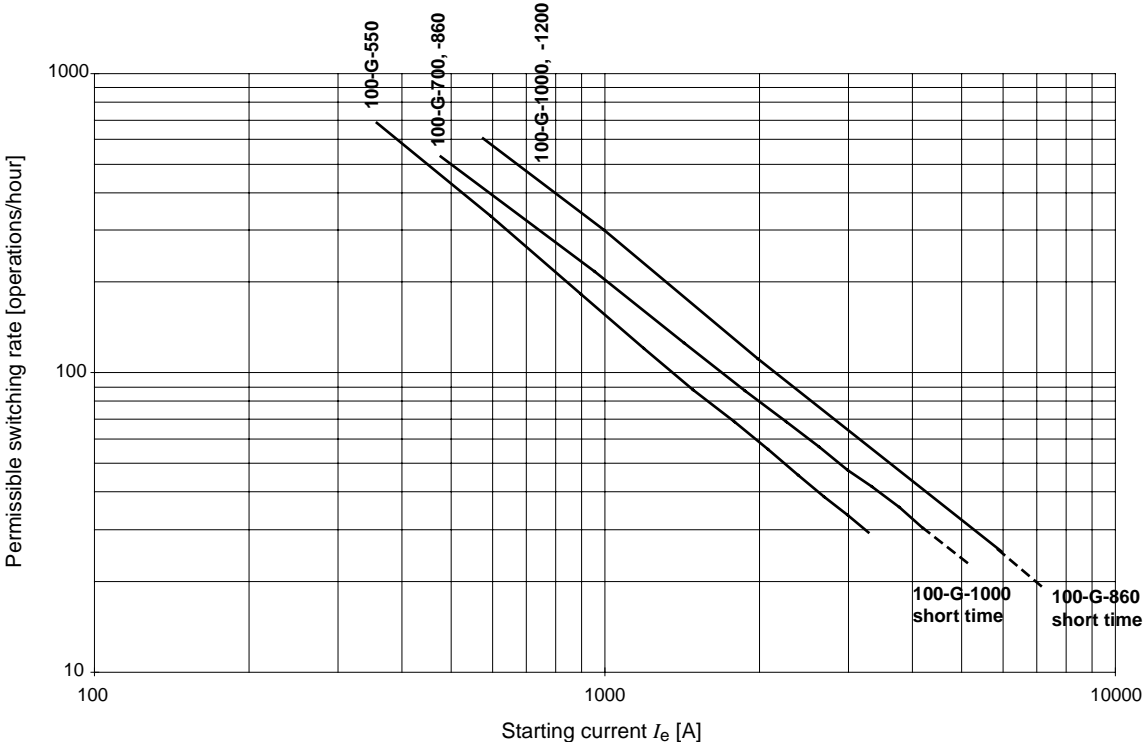

4

100-G
 Dimensions [millimetres]

Mounting Position

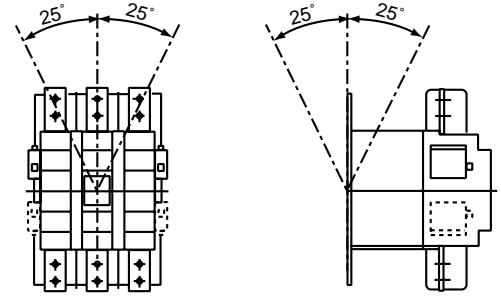
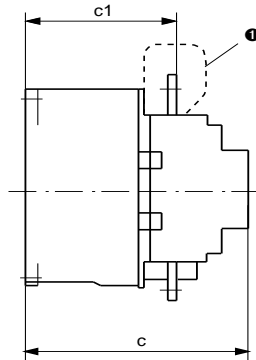
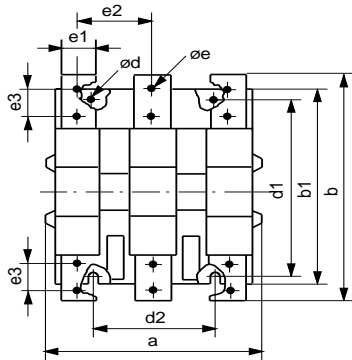

Type	a	b	b1	c	c1	ød	d1	d2	øe	e1	e2	e3
100-G550	220	258	228	225	164	9	220	110	12.5	40	79	—
100-G700	280	307	277	291	203	11	280	175	13	50	101	—
100-G860	280	361	325	291	203	11	280	175	15	50	101	—
100-G1000	334	490	434	345	231	13	380	120	2x13	50	100	40
100-G1200	334	490	434	345	231	13	380	120	2x13	60	100	40

Contactors with:	100-G	[mm]
Auxiliary contact block		a
mechanical interlock		
side-by-side	100-G550/100-G550 100-G700, G860/100-G700, G860 100-G1000, G1200/100-G1000, G1200 100-G550/100-G700, G860 100-G700, G860/100-G1000, G1200	a+42+a a+32+a a+46+a a+37+a a+73+a
stacked vertically	100-G550/100-G550 100-G700, G860/100-G700, G860 100-G1000, G1200/100-G000, G1200 100-G550/100-G700, G860 100-G700, G860/100-G1000, G1200	b+56 + b b+100...200+b b+230...280+b b+100...200+b b+230...280+b
4 th main pole	100-G550 100-G700, G860 100-G1000, G1200	a+74 a+68 a+76
mechanical latch	100-G550 100-G700 100-G860 100-G1000, G1200	b+59 b+64 b+37 a+30

i Insulation partition plate 100-G1200 (UL regulation)