

# Ultraschall Abstandssensor Ultrasonic Distance Sensor Capteurs Ultrasoniques

P43-25-R40-PBT-P-CM8

Artikelnr. / code nr.: 515153

(P43-K4U-2G-001-400E)



Technical Data	Technische Daten	Données techniques	
Max. sensing distance	Max. Reichweite	Portée	250 mm
Min. sensing distance	Min. Reichweite	Distance minimale	25 mm
Switching frequency	Schaltfrequenz	Fréquence de commutation	25 Hz
Hysteresis	Hysteresis	Hystérésis	2%
Repeatability	Wiederholgenauigkeit	Répétabilité	0.3 mm
Beam angle	Schallkeule	Angle de faisceau	8°
Temperature range	Temperaturbereich	Température de service	-10 ... +70 °C
Temperature compensation	Temperaturkompensation	Compensation en température	Yes/Ja/Oui
Operating voltage	Betriebsspannung	Tension de service	10... 30 Vdc
Current consumption	Stromaufnahme	Courant consommé	< 100 mA
Output	Ausgang	Sortie	PNP NO/NC
Output current	Ausgangsstrom	Courant sortie	100 mA max.
Adjustment set point	Schaltpunkteinstellung	Réglage des seuils	Teach IN
Teach In input	Teach In Eingang	Entrée Teach In	Pin 2/ Magnet
Plastic housing	Kunststoffgehäuse	Boîtier plastique	IP67
Sealing	Schutzart	Étanchéité	
<b>Attention !!!</b> Do not expose sensor head to hot water > 50° C or water steam!!	<b>Achtung !!!</b> Den Sensorkopf nicht heißem Wasser >50°C oder Wasserdampf aussetzen!!	<b>Attention !!!</b> Ne pas mettre en contact continu la tête du capteur avec de l'eau avec une température supérieure à 50 °C ou avec de la vapeur d'eau	
Connector	Steckeranschluß	Connexion connecteur	M8
Accessories	Zubehör	Accessoires	
Straight cable/connector 2m	Kabeldose gerade 2m	Fiche femelle droite, 2 m de câble	P66195275-001

Valid for room temperature / Gültig für Raumtemperatur / Valable pour température ambiante de 25 °C

## Dimensions / Abmessungen / Dimensions mm

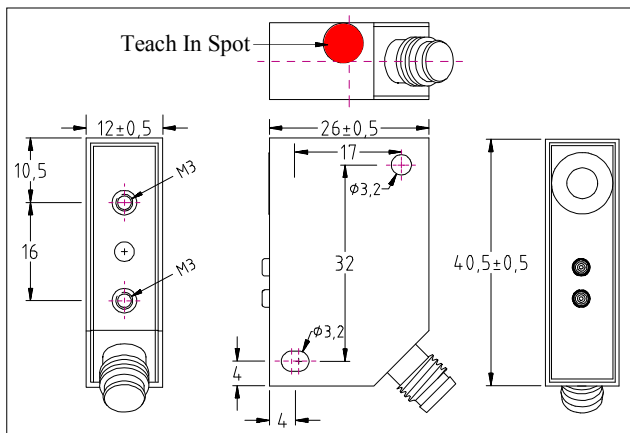

## Wiring / Anschlüsse / Raccordement électrique

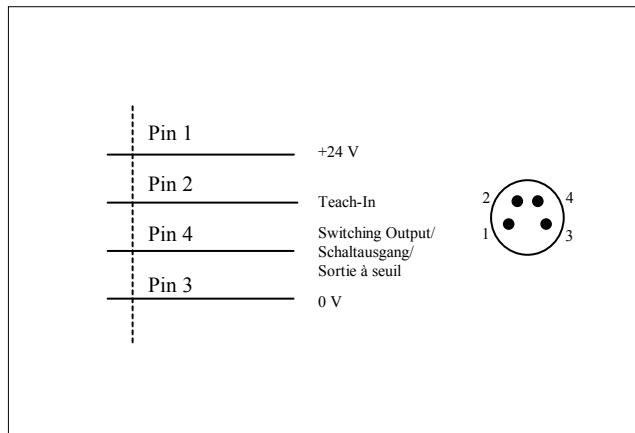

## Detection range / Erfassungsbereich / Plage de détection mm

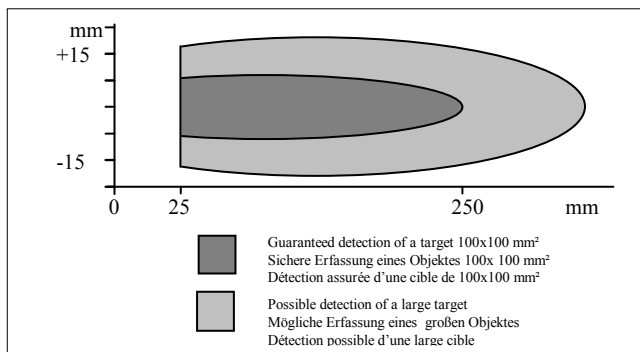

CE compliance  
Isolation is/ beträgt/ est 900V

Presence of fast transients on connections or strong electrostatic fields might affect the sensor and might require additional precautions, f. e. change of position of wires..

Die Anwesenheit von leitungsgeführten schnellen Transienten oder starken elektrischen Feldern kann zur Beeinflussung des Sensors führen und zusätzliche Maßnahmen am Einsatzort, wie z. B. Veränderung der Leitungslegung erfordern.

La présence de surtensions transitoires sur les sources d'alimentations ou de champs électrostatiques élevés pourrait affecter le capteur et pourrait exiger des précautions additionnelles comme par exemple le changement du positionnement des câbles...

P43-25-R40-PBT-P-CM8.1

## Teach in procedure/ Einlernvorgang / Procédure de mis en mémoire

<b>Normal function:</b> Yellow LED is indicating status of the switching output. Green LED indicates receiving of an Echo. (Alignment assistance)	<b>Normale Funktion :</b> Gelbe LED zeigt Schaltzustand das Ausgangs an. Grüne LED zeigt an, wenn ein Echo empfangen wird. (Ausrichthilfe)	<b>Fonctionnement normal du capteur:</b> La DEL jaune indique l'état du sortie à seuil. La DEL verte sera allumée si un écho est reçu. Il s'agit d'un témoin d'alignement.
--	---	---

Teach In	Einlernvorgang	Apprentissage
There are 2 ways of teaching the sensor: I Connect and disconnect Teach In input (Pin 2) with GND (0V) or II Position and remove magnetic pen to teach in spot on the bottom of the housing. Position of the magnetic pin corresponds to connection of teach in line to GND and remove the magnetic pen from this spot corresponds to disconnect the teach in line.	Es gibt 2 Möglichkeiten den Sensor einzustellen: I Verbinden und trennen des Teach-In Eingangs (Pin 2) mit GND (0V) oder II Den Magnetstift an die Teach-In Stelle unten am Gehäuse halten und wieder entfernen. Das Halten an die Teach-In Stelle entspricht dem Verbinden des teach-In Eingangs mit GND und das Entfernen des Magnetstifts entspricht dem Trennen des Teach-In Eingangs.	Il y a 2 possibilités pour l'apprentissage I Connecter et déconnecter la sortie apprentissage (Pin2) avec GND (0V) ou II Placer et déplacer le bouton magnétique au position apprentissage vers le bas de la boîte. Placement du bouton magnétique corresponds connexion sortie apprentissage avec GND et déplacement corresponds au déconnexion de la sortie apprentissage.

<b>A Switching output with 1% hysteresis</b>	<b>A Schaltpunkt mit 1% Hysterese</b>	<b>A Sortie à seuil avec une hystérésis de 1 %</b>
--	---------------------------------------	--

### Schaltfunktion

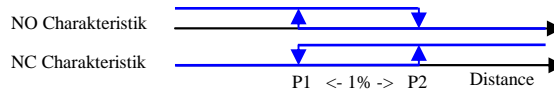

<ol style="list-style-type: none"> <li>1. Connect Teach In line with GND (0V) ~8 sec until yellow LED starts blinking ~ 2Hz.</li> <li>2. Disconnect: sensor now in teach-in mode: Yellow LED is now blinking ~ ½ Hz. Within 35 sec. set point has to be set.</li> <li>3. Position object to desired switching position P1.</li> <li>4. Connect and disconnect teach-in line with GND (0V). Switching output is taught. P2 is 1% farer from the sensor than P1.</li> </ol> <p><b>Switching characteristic NO/NC</b> Is yellow LED 'on' during teach-in setting P1 (#4), sensor has NO characteristics, is it 'off', sensor has NC characteristic.</p> <ol style="list-style-type: none"> <li>5. Sensor is now operating in <b>normal function</b>.</li> </ol>	<ol style="list-style-type: none"> <li>1. Verbinden Sie den Teach-In Eingang mit GND (0V) ~ 8 sec. bis gelbe LED mit ~2 Hz blinkt.</li> <li>2. Verbindung trennen: jetzt ist Sensor im Tech In Modus: gelbe LED blinkt mit ~ ½ Hz. Innerhalb von 35 sec. muss der Schaltpunkt eingelernt werden!</li> <li>3. Objekt an gewünschten Schaltabstand P1 bringen</li> <li>4. Teach-In Eingang kurz mit GND (0V) verbinden und wieder trennen. Der Schaltpunkt P1 ist eingelernt. P2 liegt 1% weiter vom Sensor entfernt</li> </ol> <p><b>Schaltcharakteristik NO/NC</b> Ist beim Einlernen des Schaltpunktes P1 (#4) die LED ,an', so hat der Schaltpunkt NO Charakteristik, ist sie aus, so ist die Charakteristik NC.</p> <ol style="list-style-type: none"> <li>5. Sensor arbeitet jetzt in <b>normaler Funktion</b> mit neuem eingestellten Wert.</li> </ol>	<ol style="list-style-type: none"> <li>1. Connecter la sortie apprentissage avec GND (0V) environ 8 s jusqu'à clignotement de la DEL jaune à une fréquence de ~ 2 Hz.</li> <li>2. Déconnecter la sortie apprentissage: le capteur est maintenant en mode programmation pour P1: la DEL jaune clignote a une fréquence de ~ ½ Hz. A ce moment, une séquence de 35 s commence pour effectuer la programmation de la position P1</li> <li>3. Placer l'objet à la nouvelle position désirée de P1.</li> <li>4. Connecter et déconnecter la sortie apprentissage à la masse GND (0V) P1 est maintenant programmée. P2 se trouve a une position 1% plus grande que P1 avant le capteur.</li> </ol> <p><b>Choix entre sortie NO / NF</b> Si pendant la procédure apprentissage de P1 (#4) la DEL jaune est allumée sortie est NO, Lorsque la DEL est éteint sortie est NF.</p> <ol style="list-style-type: none"> <li>5. Le capteur retourne après la procédure finie en <b>fonction normale</b> avec la nouvelle valeur.</li> </ol>
--	---	---

<b>B Switching output with teach-in Hysteresis with NO characteristics (P2)</b>	<b>B Schaltpunkt mit eingelernter Hysterese mit NO Schaltcharakteristik (Einstellen P2)</b>	<b>B Sortie à seuil avec une autre hystérésis (P2) NO.</b>
---	---	--

#### Hysteresis Adjustment

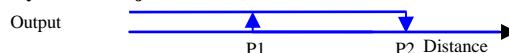

<ol style="list-style-type: none"> <li>1 Teach is switching output NO at distance P1 as described in A</li> <li>2 Teach in P2: Connect teach in line with GND (0V) around 16 sec. First after ~8 sec. yellow LED is blinking with ~2 Hz, after additional 8 sec. Yellow LED is blinking with 1 Hz.</li> <li>3. Disconnect teach in line: sensor is now in teach in mode for P2: yellow LED is blinking with ~ ½ Hz.</li> <li>4. Position object in Position of P2.</li> <li>5. <b>When yellow LED on:</b> connect each in line with GND (0V) and disconnect. Sensor is now programmed.</li> </ol>	<ol style="list-style-type: none"> <li>1 Einlernen des Schaltpunktes NO am Abstand P1 wie unter A beschrieben.</li> <li>2 Einlernen P2: Verbinden Sie den Teach-In Eingang mit GND (0V) ~ 16 sec. Zunächst –nach ~ 8 sec.- blinkt gelbe LED mit ~2 Hz, nach weiteren 8 sec. blinkt gelbe LED mit 1 Hz</li> <li>3. Verbindung trennen: jetzt ist Sensor im Tech In Modus für P2: gelbe LED blinkt mit ~ ½ Hz.</li> <li>4. Objekt an gewünschten Hysterese-Schaltabstand P2 bringen</li> <li>5. <b>Wenn gelbe LED an:</b> Teach-In Eingang kurz mit GND (0V) verbinden und wieder trennen. Der Sensor ist jetzt wie gewünscht programmiert</li> </ol>	<ol style="list-style-type: none"> <li>1. Apprentissage de la sortie à seuil NO a la distance P1 (décrit à A).</li> <li>2. Apprentissage P2 : Connecter la sortie apprentissage avec GND (0V) environ 16 s. D'abord - après ~8 s - la DEL jaune clignote ~2 Hz et après encore 8 s la DEL jaune clignote ~ 1 Hz.</li> <li>3. Déconnecter la sortie apprentissage: le capteur est maintenant en mode programmation pour P2 : la DEL jaune clignote ~ ½ Hz.</li> <li>4. Placer l'objet à la nouvelle position désirée de P2.</li> <li>5. <b>Si la DEL jaune est allumée:</b> Connecter et déconnecter la sortie apprentissage la masse GND (0V). Le capteur est programmé.</li> </ol>
---	---	---

<b>C Switching output with teach-in Hysteresis with NC characteristics</b>	<b>C Schaltpunkt mit eingelernter Hysterese mit NC Schaltcharakteristik (Einstellen P2)</b>	<b>C Sortie à seuil avec une autre hystérésis (P2) caractéristique NC.</b>
--	---	--

#### Hysteresis Adjustment

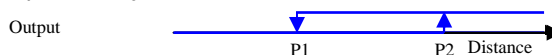

<ol style="list-style-type: none"> <li>1 Teach is switching output NC at distance P1 as described in A</li> <li>2 Teach in P2: Connect teach in line with GND (0V) around 16 sec. First after ~8 sec. yellow LED is blinking with ~2 Hz, after additional 8 sec: yellow LED is blinking with 1 Hz.</li> <li>3. Disconnect teach in line: sensor is now in teach in mode for P2, yellow LED is blinking with ½ Hz.</li> <li>4. Position object in Position of P2.</li> <li>5. <b>When yellow LED off:</b> connect each in line with GND (0V) and disconnect. Sensor is now programmed.</li> </ol>	<ol style="list-style-type: none"> <li>1 Einlernen des Schaltpunktes NC am Abstand P1 wie unter A beschrieben.</li> <li>2 Einlernen P2: Verbinden Sie den Teach-In Eingang mit GND (0V) ca. 16 sec. Zunächst –nach ca. 8 sec.- blinkt gelbe LED mit ~2 Hz, nach weiteren 8 sec. blinkt gelbe LED mit 1 Hz</li> <li>3. Verbindung trennen: jetzt ist Sensor im Tech In Modus für P2: gelbe LED blinkt mit ~ ½ Hz.</li> <li>4. Objekt an gewünschten Hysterese-Schaltabstand P2 bringen</li> <li>5. <b>Wenn gelbe LED aus:</b> Teach-In Eingang kurz mit GND (0V) verbinden und wieder trennen. Der Sensor ist jetzt wie gewünscht programmiert</li> </ol>	<ol style="list-style-type: none"> <li>1. Apprentissage de la sortie à seuil NC a la distance P1 (décrit à A).</li> <li>2. Apprentissage P2 : Connecter la sortie apprentissage avec GND (0V) environ 16. D'abord - après ~8 s - la DEL jaune clignote ~ 2 Hz et après encore 8 s la DEL jaune clignote ~ 1 Hz.</li> <li>3. Déconnecter la sortie apprentissage: le capteur est maintenant en mode programmation pour P2 : DEL jaune clignote ~ ½ Hz.</li> <li>4. Placer l'objet à la nouvelle position désirée de P2.</li> <li>5. <b>Si la DEL jaune est éteinte:</b> Connecter et déconnecter la sortie apprentissage la masse GND (0V). Le capteur est programmé</li> </ol>
--	--	--

<b>D Windows function NO switching characteristics</b>	<b>D Fensterfunktion NO Schaltcharakteristik</b>	<b>D Fonction fenêtre caractéristique NO</b>
--	--	--

#### Windows Function

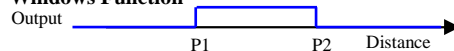

<ol style="list-style-type: none"> <li>1 Teach is switching output NC at distance P1 as described in A</li> <li>2 Teach in P2: Connect teach in line with GND (0V) around 16 sec. First after ~8 sec. yellow LED is blinking with ~2 Hz, after additional 8 sec. yellow LED is blinking with 2 Hz.</li> <li>3. Disconnect teach in line: sensor is now in teach in mode for P2: yellow LED is blinking with ½ Hz.</li> <li>4. Position object in Position of P2.</li> <li>5. <b>When yellow LED on:</b> connect each in line with GND (0V) and disconnect. Sensor is now programmed.</li> </ol>	<ol style="list-style-type: none"> <li>1 Einlernen des Schaltpunktes NC am Abstand P1 wie unter A beschrieben.</li> <li>2 Einlernen P2: Verbinden Sie den Teach-In Eingang mit GND (0V) ca. 16 sec. Zunächst –nach ca. 8 sec.- blinkt gelbe LED mit ~2 Hz, nach weiteren 8 sec. blinkt sie mit 2 Hz</li> <li>3. Verbindung trennen: jetzt ist Sensor im Tech In Modus: gelbe LED blinkt mit ~ ½ Hz.</li> <li>4. Objekt an gewünschten Fensterrand P2 bringen</li> <li>5. <b>Wenn gelbe LED an:</b> Teach-In Eingang kurz mit GND (0V) verbinden und wieder trennen. Der Sensor ist jetzt wie gewünscht programmiert</li> </ol>	<ol style="list-style-type: none"> <li>1. Apprentissage de la sortie à seuil NC a la distance P1 (décrit à A).</li> <li>2. Apprentissage P2 : Connecter la sortie apprentissage avec GND (0V) environ 16 s. D'abord –après ~8 s - la DEL jaune clignote ~2 Hz et après encore 8 s la DEL jaune clignote ~ 1 Hz.</li> <li>3. Déconnecter la sortie apprentissage: le capteur est maintenant en mode programmation pour P2 : la DEL jaune clignote ~ ½ Hz.</li> <li>4. Placer l'objet à la nouvelle position désirée de P2.</li> <li>5. <b>Si la DEL jaune est allumée:</b> Connecter et déconnecter la sortie apprentissage la masse GND (0V). Le capteur est programmé</li> </ol>
---	--	---

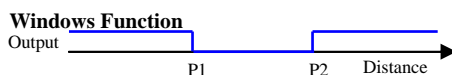

E Windows function NC switching characteristics	E Fensterfunktion NC Schaltcharakteristik	E Fonction fenêtre caractéristique NC
<ol style="list-style-type: none"> <li>1 Teach is switching output <b>NO</b> at distance P1 as described in A</li> <li>2 Teach in P2: Connect teach in line with GND (0V) around 16 sec. First after ~8 sec. yellow LED is blinking with ~2 Hz, after additional 8 sec. Yellow LED is blinking with 1 Hz.</li> <li>3. Disconnect teach in line: sensor is now in teach in mode for P2: yellow LED is blinking with ½ Hz.</li> <li>4. Position object in Position of P2.</li> <li>5. <b>When yellow LED off:</b> connect each in line with GND (0V) and disconnect. Sensor is now programmed.</li> </ol>	<ol style="list-style-type: none"> <li>1 Einlernen des Schaltpunktes <b>NO</b> am Abstand P1 wie unter A beschrieben.</li> <li>2 Einlernen P2: Verbinden Sie den Teach-In Eingang mit GND (0V) ca. 16 sec. Zunächst –nach ca. 8 sec. - gelbe LED mit ~2 Hz, nach weiteren 8 sec. blinkt sie mit 1 Hz</li> <li>3. Verbindung trennen: jetzt ist Sensor im Tech In Modus: gelbe LED blinkt mit ~ 1Hz.</li> <li>4. Objekt an gewünschten Fensterrand P2 bringen</li> <li>5. <b>Wenn gelbe LED aus:</b> Teach-In Eingang kurz mit GND (0V) verbinden und wieder trennen. Der Sensor ist jetzt wie gewünscht programmiert</li> </ol>	<ol style="list-style-type: none"> <li>1. Apprentissage de la sortie à seuil NO a la distance P1 (décrit à A).</li> <li>2. Apprentissage P2 : Connecter la sortie apprentissage avec GND (0V) environ 16 s. D'abord - après ~8 - la DEL jaune clignote ~2 Hz et après encore 8 s la DEL jaune clignote ~ 1 Hz.</li> <li>3. Déconnecter la sortie apprentissage: le capteur est maintenant en mode programmation pour P2 : la DEL jaune clignote ~ ½ Hz.</li> <li>4. Placer l'objet à la nouvelle position désirée de P2.</li> <li>5. <b>Si la DEL jaune est éteinte:</b> Connecter et déconnecter la sortie apprentissage la masse GND (0V). Le capteur est programmé.</li> </ol>

<p><b>!!! WARNING !!!</b> <b>PERSONAL INJURY</b> DO NOT USE these products as safety or emergency stop devices, or in any other application where failure of the product could result in personal injury. <b>Failure to comply with these instructions could result in death or serious injury.</b></p>	<p><b>!!! WARNUNG !!!</b> <b>PERSONENSCHADEN</b> Diese Produkte dürfen weder als Sicherheits- oder Not-Abschaltgeräte noch in anderen Anwendungen, bei denen ein Fehler an diesem Produkt zu Personenschaden führen könnte, eingesetzt werden. <b>Missachtung dieser Anweisungen kann zu schweren Verletzungen oder zum Tod führen.</b></p>	<p><b>!!! ATTENTION !!!</b> <b>BLESSURES CORPORELLES</b> NE PAS UTILISER ces produits en tant que dispositifs d'arrêt d'urgence ou de sécurité, ni dans aucune autre application où la défaillance du produit pourrait entraîner des blessures corporelles. <b>L'inobservation de ces instructions peut entraîner la mort ou de graves blessures.</b></p>
---	---	---

<p><b>Warranty/Remedy</b> PIL warrants goods of ist manufacture as being free of defective materials and faulty workmanship. If warranted goods are returned to PIL during the period of coverage, PIL will repair or replace without charge those items it finds defective. <b>The foregoing is Buyer's sole remedy and is in lieu of all other warranties, expressed or implied, including those of merchantability and fitness for a particular purpose.</b> Specifications may change without notice. The information we supply is believed to be accurate and reliable as of this printing. However we assume no responsibility for its use. While we provide application assistance personally, through our literature and the PIL web site, it is up to the customer to determine the suitability of the product in the application.</p>	<p><b>Garantie und Haftungsansprüche</b> PIL garantiert für seine hergestellten Produkte fehlerfreies Material und Qualitätsarbeit. Wenn Produkte innerhalb der Gewährleistungsfrist an PIL zurückgesendet werden, ersetzt oder repariert PIL kostenlos die Teile, die als fehlerhaft angesehen werden. <b>Das Vorangegangene gilt als einzige Entschädigung des Käufers und alle anderen ausdrücklichen oder stillschweigenden Garantien einschließlich Qualitäts- und Sachmängelhaftung.</b> Änderungen der technischen Daten ohne Vorankündigung sind vorbehalten. Die von uns bereitgestellten Informationen halten wir für exakt und zuverlässig, wie bei dieser Druckschrift. Wir übernehmen jedoch keine Haftung für deren Anwendung. Obwohl PIL persönliche und schriftliche Anwendungshilfe sowie Informationen über die PIL Webseite bietet, ist es die Entscheidung des Kunden ob das Produkt sich für die entsprechende Anwendung eignet.</p>	<p><b>Garantie/ Recours</b> PIL garantit que les articles de sa fabrication sont exempts de défaut de pièces et main d'œuvre. Si les articles garantis sont retournés à PIL pendant la période de couverture, PIL réparera ou remplacera gratuitement ceux qui auront été trouvés défectueux. <b>Ce qui précède constitue le seul recours de l'acheteur et se substitue à toutes autres garanties explicites ou implicites, y compris celles relatives à la commercialisation ou la compatibilité avec une application particulière.</b> Les caractéristiques techniques peuvent changer sans préavis. Les informations que nous apportons sont présumées précises et fiables au moment de la mise sous presse. Cependant, nous déclinons toute responsabilité quant à leur utilisation. Bien que nous apportons notre aide pour les applications, de façon individuelle, par notre littérature et par le site web PIL, il incombe au client de déterminer si le produit convient à l'application.</p>
---	---	--